

Selection Guide..... 430

Type 2 SG2 Series  
(Basic & Extended Models)..... 431

Type 4 SG4 Series..... 435

Mounting Brackets and Accessories ..... 439

# Light Curtains



[www.IDEC.com/safety](http://www.IDEC.com/safety)



Selection Guide

Overview

Series	Type 2 Safety Category		Type 4 Safety Category	
	SG2 - Hand Series	SG2 - Presence Series	SG4 - Finger Series	SG4 - Hand Series

Appearance



XW Series E-Stops

Page	431		435	
Protection Type	Type 2		Type 4	
Resolution	30mm	50mm, 90mm	14mm	30mm
Material	Painted Aluminum		Painted Aluminum	

Interlock Switches

Enabling Switches

Safety Control

Light Curtains

AS-Interface Safety at Work

**Type 2 SG2 Series (Basic & Extended Models)**

**Hand Protection**



**Presence Protection**

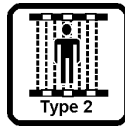

**Type 2 SG2 features:**

- Integrated light curtain for Hand or Presence Protection
- Operating distance up to 19m
- Sensing field heights from 150 to 1800mm
- Compact 32 x 37mm profile
- Sturdy profile and rotating brackets
- Test/Restart, Auto/Manual Restart, EDM, Anti-interference
- User interface with display
- Alignment function

The SG2 Type 2 series offers two models, the SG2 basic and the SG2 extended. Available functions include Test/Restart, EDM and Anti-interference. With very fast response times, the SG2 series can be installed right next to a dangerous area, improving productivity. The adjustable mounting brackets make installation and the alignment of emitting and receiving units easy, even at long distances and in applications that use mirrors.



**Part Numbers**

Part Number	Protection Type	Resolution	Features
SG2-30-□-00-X			Basic Model - Test/Reset
SG2-30-□-00-E-C			Extended Model - Test/Reset, Auto/Manual Restart, EDM
SG2-50-□-00-X			Basic Model - Test/Reset
SG2-50-□-00-E-C			Extended Model - Test/Reset, Auto/Manual Restart, EDM
SG2-90-□-00-X			Basic Model - Test/Reset
SG2-90-□-00-E-C			Extended Model - Test/Reset, Auto/Manual Restart, EDM

**Sensing Field Height Code**





Sensing Field Height	Code
150mm <sup>1</sup>	015 <sup>1</sup>
300mm	030
450mm	045
600mm	060
750mm	075
900mm	090
1050mm	105
1200mm	120
1350mm	135
1500mm	150
1650mm	165
1800mm	180

In place of □ enter the Height code. See table on the right.

1. Not applicable to SG2 Presence Series

Accessories

M12 Unshielded Axial Connector Cable

Item	# of Poles	Used For	Cable Length	Part Number	
	4		SG4 & SG2 Emitters	3m	CS-A1-02-U-03
				5m	CS-A1-02-U-05
				10m	CS-A1-02-U-10
				15m	CS-A1-02-U-15
				25m	CS-A1-02-U-25
	5		SG2 Basic Model Receivers	3m	CS-A1-03-U-03
				5m	CS-A1-03-U-05
				10m	CS-A1-03-U-10
				15m	CS-A1-03-U-15
	8		SG4 & SG2 Extended Model Receivers	25m	CS-A1-03-U-25
				3m	CS-A1-06-U-03
				5m	CS-A1-06-U-05
10m				CS-A1-06-U-10	
			15m	CS-A1-06-U-15	
			25m	CS-A1-06-U-25	

Mounting Brackets

Item	Description	Part Number
	Angled mounting brackets (4 pc kit)	ST-KSTD
	Anti-vibration supports (4 pc kit)	ST-K4AV
	Anti-vibration supports (6 pc kit)	ST-K6AV
	Top-Bottom adjustable mounting brackets (4 pc kit)	ST-K4ROT

Laser Pointer

Item	Description	Part Number
	Laser pointer used to aid in aligning safety light curtains.	SG-LP

Overview

XW Series E-Stops

Interlock Switches



Enabling Switches

Safety Control

Light Curtains

AS-Interface Safety at Work

## Specifications

SG2 - Hand Series	SG2 - Presence Series
	

Electrical	Power supply (Vdd)	24V DC ± 20%	
	Power (TX)	2.5W max	
	Power (RX)	3.5W max (without load)	
	OSSD outputs	2 PNP (push-pull)	
	Short-circuit protection	1.4A max	
	Output current	0.5A max on each output	
	Output voltage – ON status	Vdd-1V min	
	Output voltage – OFF status	0.2V max	
	Leakage current	< 1mA	
	Capacitive load	2.2 uF @ 24V DC max*	
Optical	Height	150 - 1800mm	300 - 1800mm
	Auxiliary functions	Test/Reset, Auto/Manual Restart (extended), EDM (extended)	
	Electrical protection	Class I / Class III	
	Connections	M12: Emitter 4 pole, Receiver 5 pole (basic), 8 pole (extended)	
	Cable length (for powering)	50m. max *	
	Light emission	Infrared LED (950nm)	
	Resolution	30mm	50mm / 90mm
	Operating distance	0.2m-19m (basic) or selectable 0.2m-9m / 0.2-19m (extended)	
	Aperture angle (EAA)	±5°	
	Ambient light rejection	IEC 61496-2	
Mechanical & Environmental	Operating temperature	0 - 55°C	
	Storage temperature	-25 to +70°C	
	Temperature class	T6	
	Humidity	15 - 95% (no condensation)	
	Mechanical protection	IP65 (EN 60529)	
	Vibration	0.35mm amplitude, 10 - 55 Hz frequency 20 sweep per axis, 1 octave/min (EN 60068-2-6)	
	Shock resistance	16ms (10g) 1.000 shock per axis, (EN 60068-2-29)	
	Housing material	Painted aluminium (yellow)	
	Protective shield material	PMMA	



\* If a longer cable is needed, please verify that the capacitive load specifications are followed.

### Sensing Field Heights

Height
150mm <sup>1</sup>
300mm
450mm
600mm
750mm
900mm
1050mm
1200mm
1350mm
1500mm
1650mm
1800mm

### Number of Beams

Height	SG2 Hand	SG2 Presence	
		50mm	90mm
150	8	–	–
300	16	9	5
450	24	13	7
600	32	17	9
750	40	21	11
900	48	25	13
1050	56	29	15
1200	64	33	17
1350	72	37	19
1500	80	41	21
1650	88	45	23
1800	96	49	25

### Response Time (ms)

Height	SG2 Hand	SG2 Presence	
		50mm	90mm
150	8	–	–
300	9	9	9
450	11	10	10
600	12	11	11
750	14	12	12
900	15	14	13
1050	17	15	14
1200	18	16	15
1350	20	17	16
1500	21	18	17
1650	23	19	18
1800	24	20	19



1. Not applicable to SG2 Presence Series

Overview

XW Series E-Stops

Interlock Switches

Enabling Switches

Safety Control

Dimensions (mm)

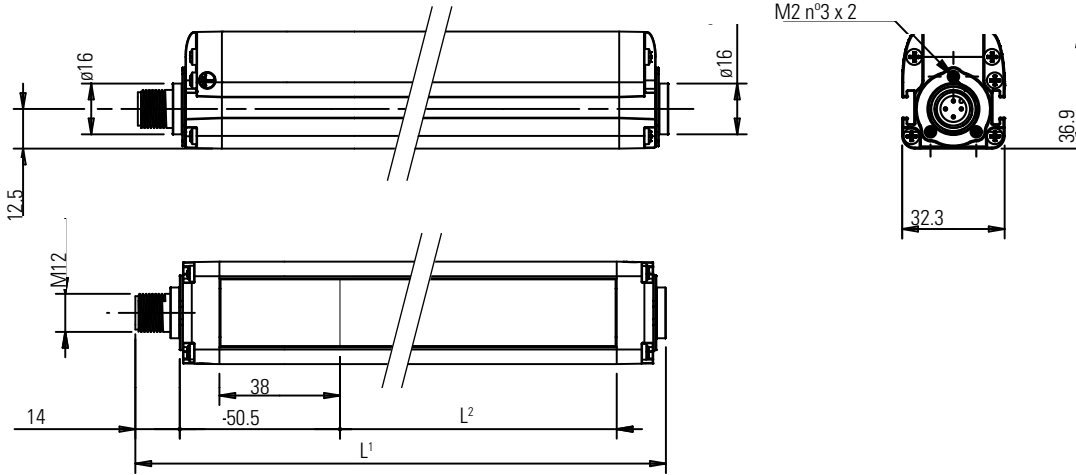

Dimension Table

Model	L <sup>1</sup>	L <sup>2</sup>
150 <sup>1</sup>	233.3	153.3
300	383.2	303.2
450	533.2	453.3
600	683.2	603.2
750	833.2	753.3
900	983.2	903.2
1050	1133.2	1053.2
1200	1283.3	1203.3
1350	1433.2	1353.2
1500	1583.3	1503.3
1650	1733.3	1653.3
1800	1883.3	1803.3



1. Not applicable to SG2 Presence Series

Dimensions (mm)  
SG2 Basic Models

M12 5-Pole Connector

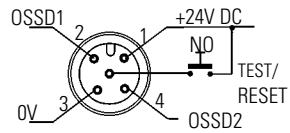

Pin	Cable Color	Function
1	brown	+24V DC
2	white	OSSD1
3	blue	0V
4	black	OSSD2
5	gray	TEST/RESET

M12 4-Pole Connector

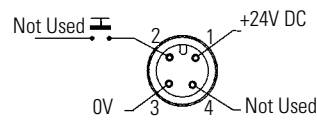

Pin	Cable Color	Function
1	brown	+24V DC
2	white	Not Used
3	blue	0V
4	black	Not Used

SG2 Extended Models

M12 8-Pole Connector

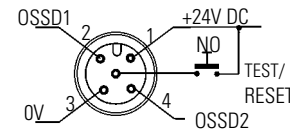

Pin	Cable Color	Function
1	white	RESET <sup>1</sup>
2	brown	+24V DC
3	green	EDM Activation
4	yellow	EDM
5	gray	OSSD1
6	pink	OSSD2
7	blue	0V
8	red	SEL MAN / AUTO RESTART

M12 4-Pole Connector

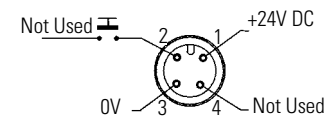

Pin	Cable Color	Function
1	brown	+24V DC
2	white	TEST
3	blue	0V
4	black	SG2: SEL operating distance



1. Automatic RESTART - RESET function  
Manual RESTART - RESET/RESTART function

Light Curtains

AS-Interface Safety at Work

### Type 4 SG4 Series

#### Finger Protection

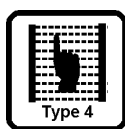

#### Hand Protection

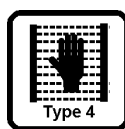



#### Type 4 SG4 features:

- Integrated light curtain for Finger Protection or Hand Protection
- Operating distance up to 6m for Finger Protection series and 19m for Hand Protection series
- Sensing field heights from 150 to 1800mm
- Compact 32 x 37mm profile
- Sturdy profile and adjustable brackets
- Test/Restart, Auto/Manual Restart, EDM
- User interface with display
- Alignment function

With mounting brackets that rotate, no connection is necessary between emitter and receiver, and configuration can be accomplished without external control units or supplementary cables. In addition, the light curtains can be aligned using the 7 segment display on either the emitter or receiver.

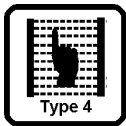
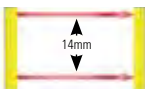
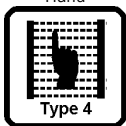

#### Part Numbers

Part Number	Protection Type	Resolution	Features
SG4-14-□-00-E	Finger 		Test/Reset, Auto/Manual Restart, EDM
SG4-30-□-00-E	Hand 		Test/Reset, Auto/Manual Restart, EDM

 In place of □ enter the Height code. See table on the right.



#### Sensing Field Height Code

Sensing Field Height	Code
150mm <sup>1</sup>	015 <sup>1</sup>
300mm	030
450mm	045
600mm	060
750mm	075
900mm	090
1050mm	105
1200mm	120
1350mm	135
1500mm	150
1650mm	165
1800mm	180

 1. Not applicable to SG2 Presence Series

Accessories

M12 Unshielded Axial Connector Cable

Item	# of Poles	Used For	Cable Length	Part Number
	4	 SG4 & SG2 Emitters	3m	CS-A1-02-U-03
			5m	CS-A1-02-U-05
			10m	CS-A1-02-U-10
			15m	CS-A1-02-U-15
			25m	CS-A1-02-U-25
	8	 SG4 & SG2 Extended Model Receivers	3m	CS-A1-06-U-03
			5m	CS-A1-06-U-05
			10m	CS-A1-06-U-10
			15m	CS-A1-06-U-15
			25m	CS-A1-06-U-25

Mounting Brackets

Item	Description	Part Number
	Angled mounting brackets (4 pc kit)	ST-KSTD
	Anti-vibration supports (4 pc kit)	ST-K4AV
	Anti-vibration supports (6 pc kit)	ST-K6AV
	Top-Bottom adjustable mounting brackets (4 pc kit)	ST-K4ROT

Laser Pointer

Item	Description	Part Number
	Laser pointer used to aid in aligning safety light curtains.	SG-LP

Overview

XW Series E-Stops

Interlock Switches

Enabling Switches



Safety Control

Light Curtains

AS-Interface Safety at Work



## Specifications

SG4 - Finger Protection Type	SG4 - Hand Protection Type
	

	SG4 - Finger Protection Type		SG4 - Hand Protection Type	
<b>Electrical</b>	Power supply (Vdd)	24V DC ± 20%		
	Power (TX)	2.5W max		
	Power (RX)	4W max (without load)		
	OSSD outputs	2 PNP (push-pull)		
	Short-circuit protection	1.4A max		
	Output current	0.5A max on each output		
	Output voltage – ON status	Vdd-1V		
	Output voltage – OFF status	0.2V max		
	Leakage current	< 1mA		
	Capacitive load	2.2 uF @ 24V DC*		
	Height	150 - 1800mm		
	Auxiliary functions	Test/Reset, Auto/Manual Restart, EDM		
Electrical protection	Class I / Class III			
Connections	M12: Emitter 4 pole, Receiver 8 pole			
Cable length (for powering)	50m. max *			
<b>Optical</b>	Light emission	Infrared LED (950nm)		
	Resolution	14mm	30mm	
	Operating distance	0.2 - 6m	0.2 - 19m	
	Aperture angle (EAA)	±2.5°		
	Ambient light rejection	IEC 61496-2		
<b>Mechanical &amp; Environmental</b>	Operating temperature	0 - 55°C		
	Storage temperature	-25 to +70°C		
	Temperature class	T6		
	Humidity	15 - 95% (no condensation)		
	Mechanical protection	IP65 (EN 60529)		
	Vibration	0.35mm amplitude, 10 - 55 Hz frequency 20 sweep per axis, 1 octave/min (EN 60068-2-6)		
	Shock resistance	16ms (10g) 1.000 shock per axis, (EN 60068-2-29)		
	Housing material	Painted aluminium (yellow)		
Protective shield material	PMMA			



\* If a longer cable is needed, please verify that the capacitive load specifications are followed.

### Sensing Field Heights

Height
150mm
300mm
450mm
600mm
750mm
900mm
1050mm
1200mm
1350mm
1500mm
1650mm
1800mm

### Number of Beams

Height	SG4 Finger	SG4 Hand
150	16	8
300	32	16
450	48	24
600	64	32
750	80	40
900	96	48
1050	112	56
1200	128	64
1350	144	72
1500	160	80
1650	176	88
1800	192	96

### Response Time (ms)

Height	SG4 Finger	SG4 Hand
150	11	9
300	15	11
450	18	13
600	22	14
750	25	16
900	29	18
1050	33	19
1200	36	21
1350	40	23
1500	43	25
1650	47	26
1800	50	28

Dimensions (mm)

Dimension Table

Overview

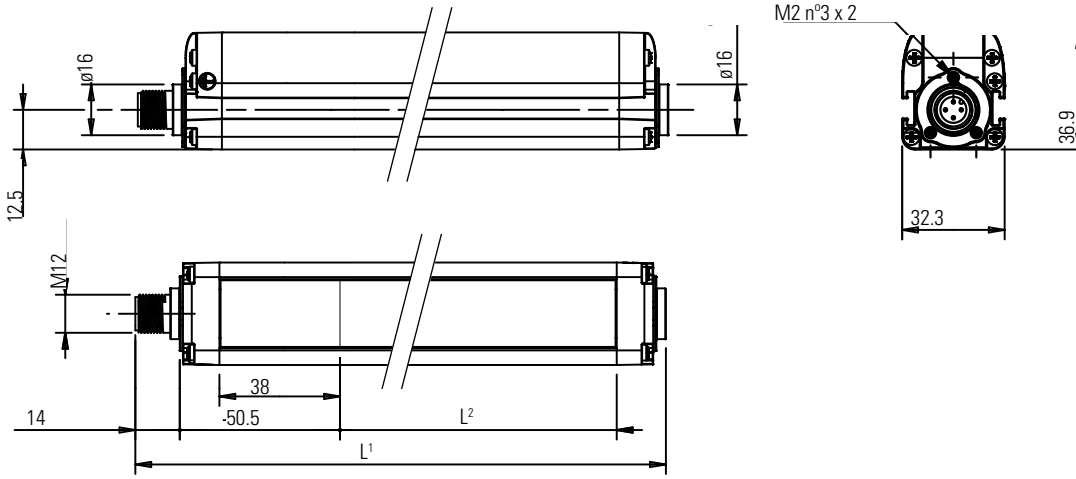

Model	L <sup>1</sup>	L <sup>2</sup>
150 <sup>1</sup>	233.3	153.3
300	383.2	303.2
450	533.2	453.3
600	683.2	603.2
750	833.2	753.3
900	983.2	903.2
1050	1133.2	1053.2
1200	1283.3	1203.3
1350	1433.2	1353.2
1500	1583.3	1503.3
1650	1733.3	1653.3
1800	1883.3	1803.3

XW Series E-Stops

Interlock Switches

Dimensions (mm)

SG4 Models

M12 8-Pole Connector

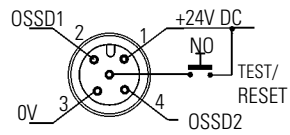

M12 4-Pole Connector

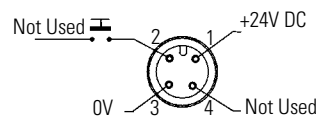

Enabling Switches

Pin	Cable Color	Function
1	white	RESET <sup>1</sup>
2	brown	+24V DC
3	green	EDM Activation
4	yellow	EDM
5	gray	OSSD1
6	pink	OSSD2
7	blue	OV
8	red	SEL MAN / AUTO RESTART

Pin	Cable Color	Function
1	brown	+24V DC
2	white	TEST
3	blue	OV
4	black	SG2: SEL operating distance

Safety Control



1. Automatic RESTART - RESET function  
Manual RESTART - RESET/RESTART function

Mounting Bracket and Accessories

Mounting Brackets Dimensions (mm)

Adjustable Mounting Bracket <sup>1</sup> (ST-K4ROT)

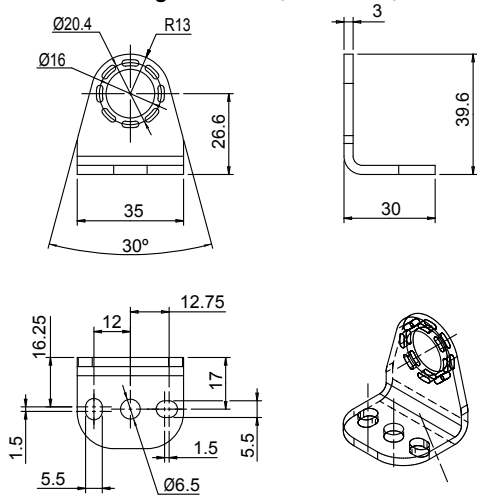

1. Supplied with the SG2 extended models only.

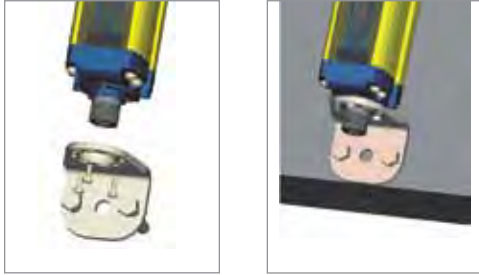

Angled Mounting Bracket <sup>2</sup> (ST-KSTD)

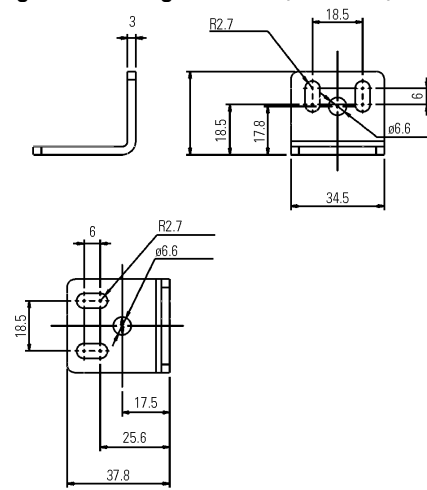

2. Supplied with SG2 standard models and all SG4 models.

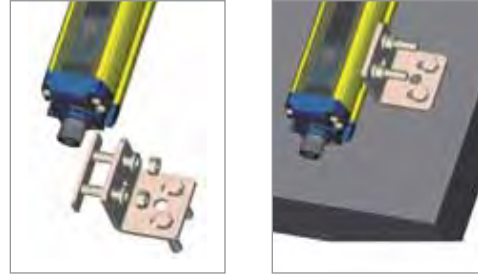

Anti-vibration Support Brackets (ST-K4AV/ST-K6AV)

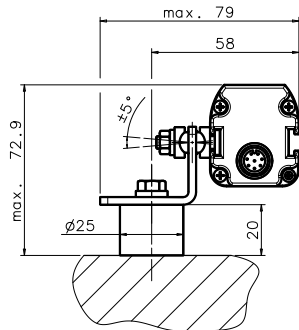

Mounting Bracket with Light Curtain (mm)

Mounting Bracket Dimension Table (mm)

Height	L	A	B	C
150*	216.3	108	54	-
300	366.2	216	75	-
450	516.3	316	100	-
600	666.2	366	150	-
750	816.3	466	175	-
900	966.2	566	200	-
1050	1116.2	666	225	-
1200	1266.3	966	150	483
1350	1416.2	1066	175	533
1500	1566.3	1166	200	583
1650	1716.3	1266	225	633
1800	1866.3	1366	250	683



1. Not applicable to SG2 Presence Series

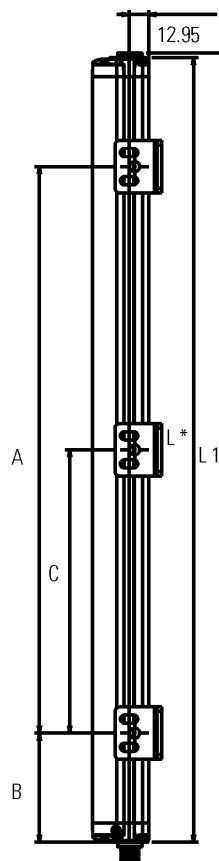

Indicators & Settings

SG4 and SG2 light curtains are equipped with an Alignment system that shows alignment status on a visual display, making configuration quick and easy. Alignment level and any change in environment conditions (presence of dust, light disturbance, etc.) are monitored during normal operating mode. The display also gives diagnostic messages to ensure accurate and correct functioning.

Overview

XW Series E-Stops

Interlock Switches

Enabling Switches

Safety Control

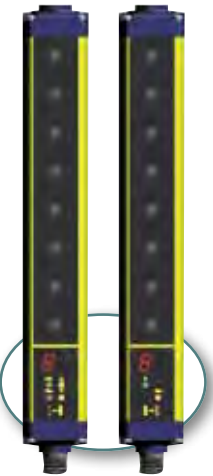
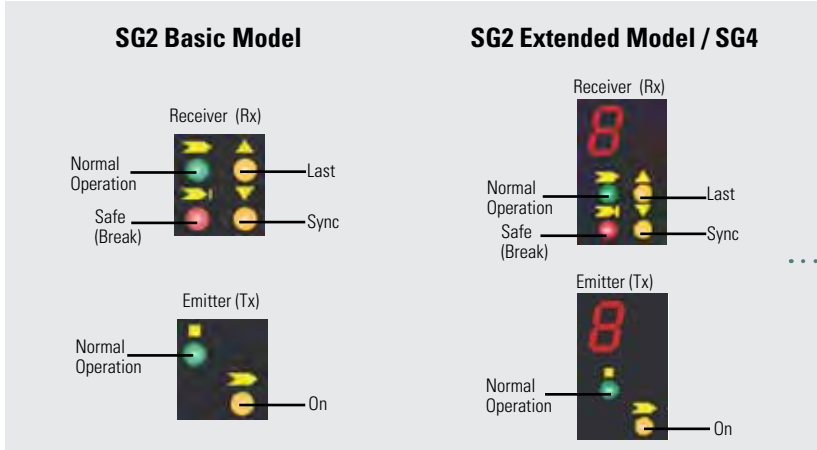

Light Curtains

AS-Interface Safety at Work