

Selection Guide.....	58
MicroSmart Family.....	59
MicroSmart Pentra CPU Part Numbers.....	66
MicroSmart CPU Part Numbers.....	67
Digital I/O Expansion Modules.....	69
Analog I/O Expansion Modules.....	72
Communication Modules.....	75
Accessories.....	80
Automation Organizer Suite.....	82
Specifications.....	83
Dimensions.....	107
IDEC SmartRelay.....	110
Part Numbers.....	112
WindLGC Software.....	114
Specifications.....	115
Dimensions.....	120

PLCs



www.IDEC.com/plc



Selection Guide
Programmable Logic Controllers

OI Touchscreens

PLCs









Automation Software

Power Supplies

Sensors

Communication

Barriers

Series	MicroSmart Family		OpenNet Controller (ONC)	SmartRelay
	MicroSmart Pentra	MicroSmart		
Appearance				
Page Number	59	67	Visit www.IDEC.com/PLC	110
Rated Voltage	12 VDC, 24 VDC, 100-240 VAC	24 VDC, 100-240 VAC	24 VDC	12-24 VDC, 24 VAC/DC, 100-240 VAC/DC
Max. Digital I/O	512	264	480	40
Max. Analog I/O	56	56	42	10
Base CPU I/O Configuration	Slim style: 12 I/Os with Ethernet, 16, 32 I/Os	Slim style: 20, 40 I/Os	CPU base module only	12 I/O
	Brick style: 10, 16, 24 I/Os	Brick style: 10, 16, 24 I/Os		
Maximum Program Capacity	128K bytes	31.2K bytes	32K bytes	2K bytes
Max. Communication Ports	7	2	3	1
Embedded Ethernet	Yes	-	-	-
Modbus TCP	Yes	-	-	-
Web Server	Yes	-	-	-
Email and Text Message	Yes	-	-	-
User Web Page	Yes	-	-	-
USB Maintenance Port	Yes	-	-	-
Networking	Modbus TCP, RTU, ASCII	Yes	-	-
	AS-interface	Yes	Yes	Yes
	INTERBUS	-	-	Yes
32-bit Data & Floating Pt. Math	Yes	-	-	-
High Speed I/O Freq.	100 kHz	20 kHz	10 kHz	2 kHz
Approvals				



The Power to Control. Anywhere. Anytime.

Power, Performance, Connectivity

Maximize efficiency and cut development time! MicroSmart Pentra PLCs combine advanced networking capabilities with unparalleled power, performance and connectivity. Designed to meet all your communication requirements, now and in the future, MicroSmart Pentra PLCs give you the flexibility to expand your system with as many as fifteen modules! Our new Embedded Ethernet PLC with built-in Modbus TCP also lets you remotely monitor status in real-time, receive email alerts and customize your own web page.

Safety

All MicroSmart Pentra PLCs meet the highest standards for safety including: cULus listed for Class 1 Division 2 hazardous locations*, CE compliant, as well as certified for marine use by ABS, DNV, and Lloyd's Registry*.



*Not applicable for all models. Visit www.IDEC.com/approvals for details.

The MicroSmart Pentra PLC Family: Everything you need in a controller



Embedded Ethernet Port

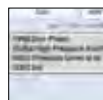

Email and text notifications



Modbus TCP, RTU and ASCII



USB programming port



Seven communication ports



NEW Advanced PID control modules



User web page



NEW 4-pt. analog output module

MicroSmart Pentra Performance

Embedded Ethernet Port

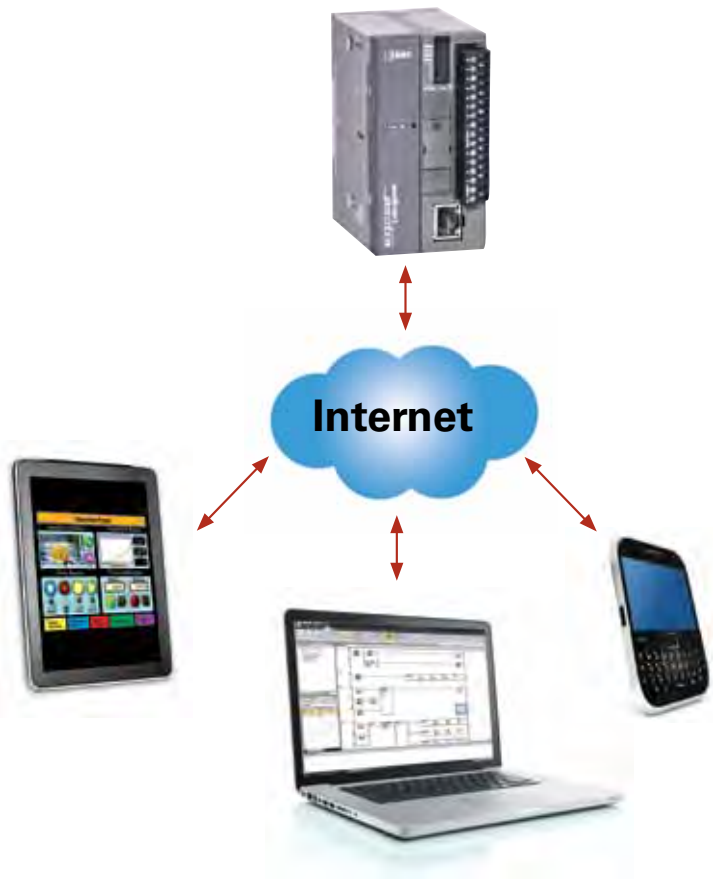

Remote Access and Control

The new MicroSmart Pentra PLC with an embedded Ethernet port, you can configure the MicroSmart Pentra PLC for remote monitoring and control. Using WindLDR software, you can remotely monitor or update the PLC programs without having to be near the PLC.

Web Server Functions

Using standard web browsers like Internet Explorer or Firefox, you can remotely log-in and access web pages that are stored directly on the MicroSmart Pentra PLC. Up to 1 MB of memory is dedicated for web page storage! Use the built-in web pages or create your own using an HTML editor.

14 Simultaneous Connections

The new embedded Ethernet Pentra supports up to 14 simultaneous connections through its Ethernet port. Through the Ethernet port, the embedded Ethernet Pentra can be configured to communicate to WindLDR for maintenance communications, to an Operator Interface touchscreen, and to VFD using Modbus TCP communications, all simultaneously.

Embedded USB Maintenance Port



The new MicroSmart Pentra PLC with an embedded Ethernet PLC port also has an embedded mini-B USB port for maintenance.

You can now easily connect your PC to this PLC using a standard USB cable.

OI Touchscreens

PLCs

Automation Software

Power Supplies

Sensors

Communication

Barriers

Modbus TCP, RTU and ASCII

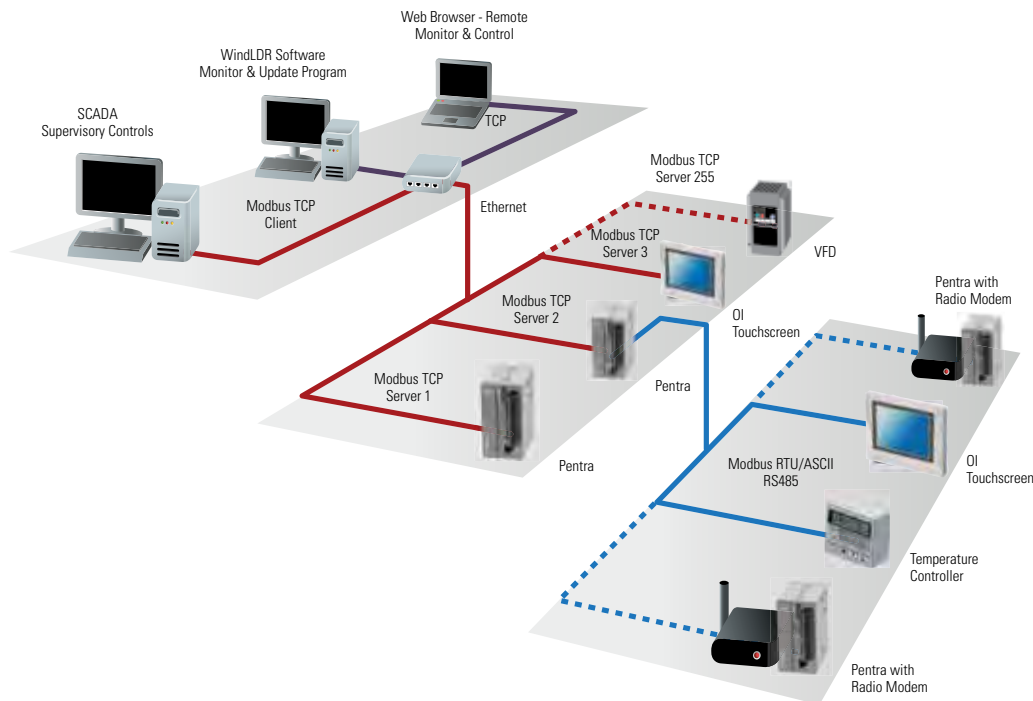

Using intuitive WindLDR software, you can configure the MicroSmart Pentra to be a Master or Slave device on a Modbus network. All MicroSmart Pentra PLCs support Modbus RTU/ASCII protocols and our CPU with embedded Ethernet port also supports Modbus TCP protocol.

Email and Text Message



Easily configure the MicroSmart Pentra PLCs to send out system status and alarms to your email or mobile phone. Data registers values in the PLC can also be incorporated in the body of the email. It also supports email login authentication so third party email server like Yahoo can be used. Up to 255 email templates can be configured with multiple recipients can be included.

OI Touchscreens

PLCs

Automation Software

Power Supplies

Sensors

Communication

Barriers

User Web Pages

01 Touchscreens

PLCs

Automation Software

Power Supplies

Sensors

Communication

Barriers



With IDEC MicroSmart Pentra, users do not need to know JAVA programming to embed dynamic values and parts on their PLC web pages. Even novice HTML programmer can take full advantage of the integrated IDEC system library of numerical display/input, horizontal and vertical bar graphs, trend chart, ON/OFF pilot lights and pushbuttons. Up to 1MB of memory is reserved for user web pages.

Integrated 100KHz Fast Inputs and Outputs

Configure up to four high-speed inputs from high-speed output devices such as rotary encoders or proximity switches at a maximum frequency of 100KHz, independent of the scan time. Up to three high-speed outputs can be used for simple positioning controls for stepper or servo motors.

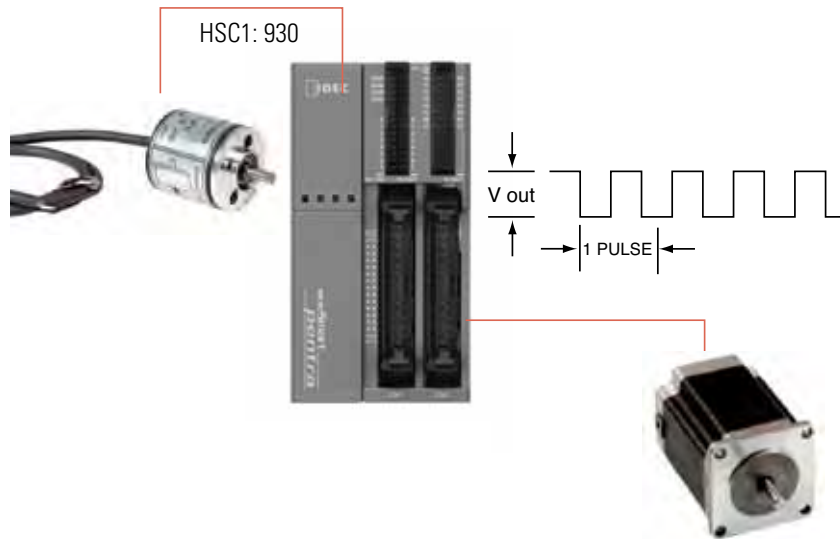

Maximum 7 Communication Ports

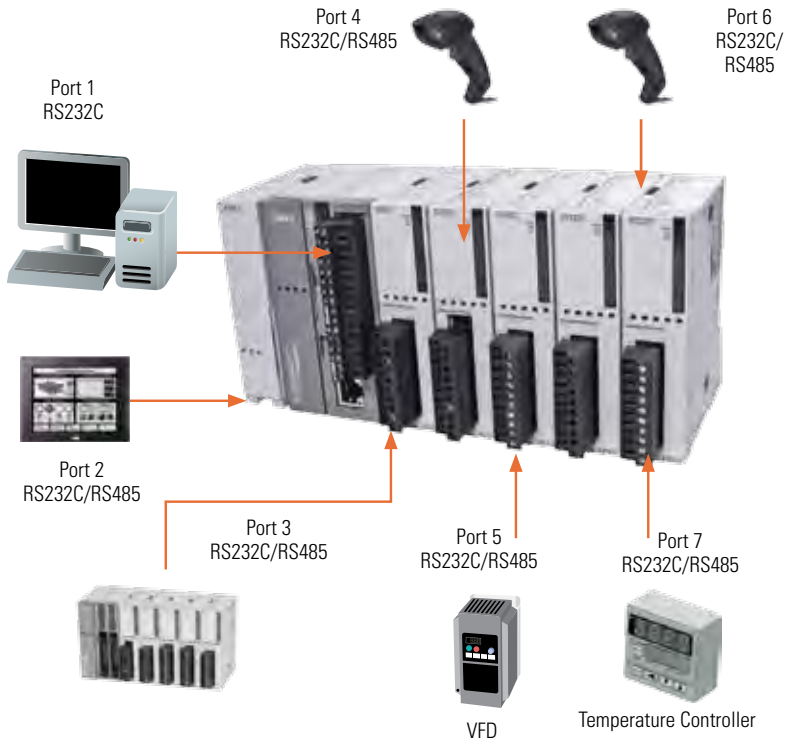

With MicroSmart Pentra PLCs, you don't have to worry about limited communication capabilities. It doesn't matter if you're just starting out or a current user expanding your MicroSmart Pentra PLC, you can rest assured that these communication modules will provide reliable and seamless communication. If RS485 modules are used for all six ports, up to 186 RS485 slave devices can be connected with as high as a 115K baud rate available for fast transmission.

01 Touchscreens

PLCs

Automation Software

Power Supplies

Sensors

Communication

Barriers

Choose a CPU for every application

With three controller types to choose from, MicroSmart Pentra PLCs offer the features you need for your applications. Built to allow you the flexibility to expand when you need to, MicroSmart Pentra PLCs are the best way to get everything you need in just one controller.

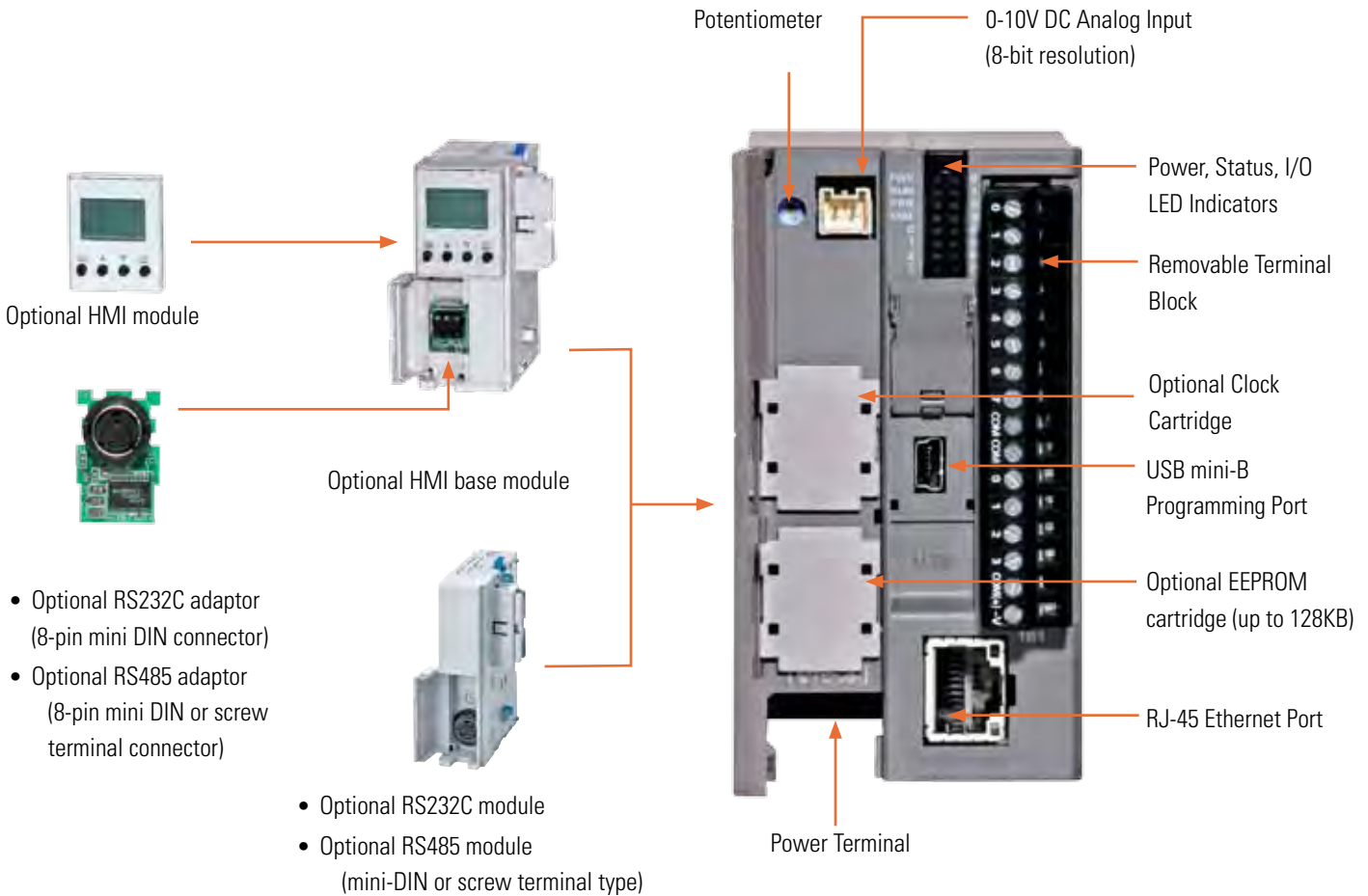

Slim CPU with Ethernet Port

The perfect design when you need Ethernet capability, this slim CPU with embedded Ethernet port is available with 24V DC power and equipped with eight DC inputs and four transistor outputs (sink or source). Up to seven functional modules, including analog and communication modules can be mounted on the right-hand expansion bus. Using an expansion interface module, an additional eight discrete expansion modules can be mounted.

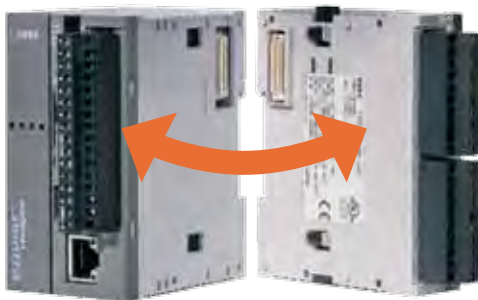

Modules snap together easily without the need for additional tools.

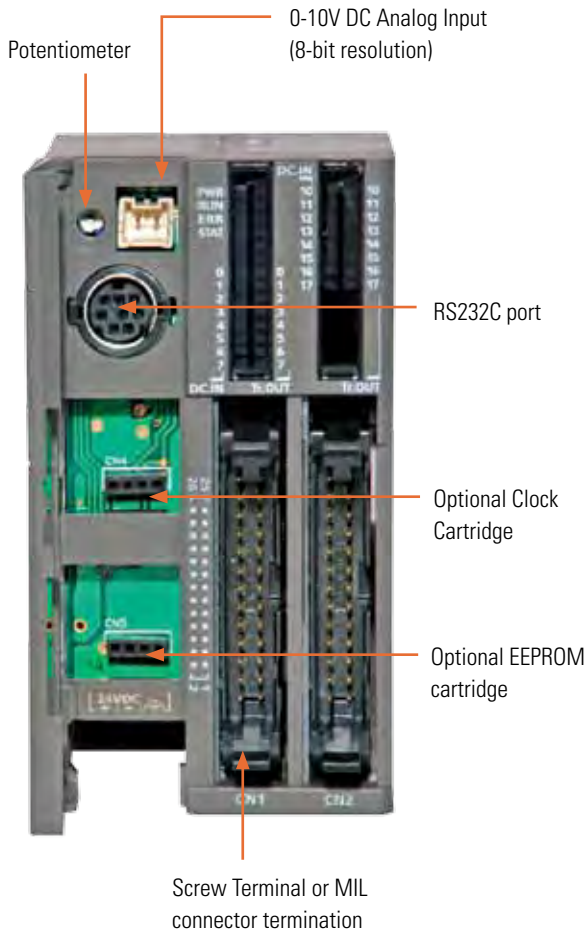

- Optional RS232C adaptor (8-pin mini DIN connector)
- Optional RS485 adaptor (8-pin mini DIN or screw terminal connector)



- Optional EEPROM cartridge
- Optional Clock Cartridge



Slim CPU

If you don't need Ethernet, but still want a high-performance CPU, the MicroSmart Pentra slim CPU is your best choice! Available with 24V DC power, this controller has all the functionalities you need in 16 and 32 I/O configurations. Each 16 I/O CPU is equipped with eight DC inputs, two transistor outputs (sink or source) and six relay outputs, while the 32 I/O CPU is equipped with 16 DC inputs and 16 transistor outputs (sink or source).

All-in-One CPU



Available with 12V DC, 24V DC and 100-240V AC power, you can choose from 10, 16 and 24 I/O configurations. The 10 I/O CPU is equipped with six DC inputs and four relay outputs, while the 16 I/O CPU is equipped with nine DC inputs and seven relay outputs. The 24 I/O CPU is equipped with 14 DC inputs and ten relay outputs. The 24 I/O CPU (24V DC and 100-240V AC models) can also be expanded with a maximum of four functional or discrete expansion modules.

MicroSmart Pentra CPU Part Numbers



Slim Base Module with Embedded Ethernet

Style	Part Number	Embedded I/Os	Operating Voltage	Ethernet & USB Port	Output	Maximum No. of Expansion Modules
	FC5A-D12K1E	12 (8in/4out)	24V DC	Yes	Transistor Sink	15 (Maximum 492 digital I/Os)
	FC5A-D12S1E				Transistor Source	

Slim Base Module

Style	Part Number	Embedded I/Os	Operating Voltage	Ethernet & USB Port	Output	Maximum No. of Expansion Modules
	FC5A-D16RK1	16 (8in/8out)	24V DC	—	6 Relays, 2 Trans. Sink	15 (Maximum 496 digital I/Os)
	FC5A-D16RS1				6 Relays, 2 Trans. Source	
	FC5A-D32K3	32 (16in/16out)	24V DC	—	Transistor Sink	15 (Maximum 512 digital I/Os)
	FC5A-D32S3				Transistor Source	

All-in-One Base Module

Style	Part Number	Embedded I/Os	Operating Voltage	Ethernet & USB Port	Output	Maximum No. of Expansion Modules
	FC5A-C10R2	10 (6in/4out)	120-240V AC	—	Relay	—
	FC5A-C10R2C		24V DC			
	FC5A-C10R2D		12V DC			
	FC5A-C16R2	16 (9in/7out)	120-240V AC	—	Relay	—
	FC5A-C16R2C		24V DC			
	FC5A-C16R2D		12V DC			
	FC5A-C24R2	24 (14in/10out)	120-240V AC	—	Relay	4 (Maximum 88 digital I/Os)
	FC5A-C24R2C		24V DC			
	FC5A-C24R2D		12V DC			

01 Touchscreens

PLCs

Automation Software

Power Supplies

Sensors

Communication

Barriers

MicroSmart Performance

Key features:

- Available in 10, 16, 20, 24, and 40 I/O CPUs.
- PID Controls
 - Program up to 14 PID loops
- High Speed I/O
 - Built-in 4 high speed inputs
 - Single or Dual Phase
 - Max. 20KHz frequency
- Built-in 2 High speed outputs (Slim model only)
- Configure up to 264 I/O Points
- Data link up to 32 MicroSmart and Pentra CPUs
- Using RS485 communication module/port, you can create a network of up to 32 CPUs.
- Worldwide Approvals
 - cULus listed, CE marked
 - Class 1 Div. 2 for hazardous locations
 - Lloyds Registered and ABS approved for shipping industry



MicroSmart CPU Part Numbers

All-in-One

Style	Part Number	Power	I/O Points	Input	Output	Maximum No. of Expansion Modules
	FC4A-C10R2C	24V DC	10 (6 in/ 4 out)	24V DC (Sink/Source)	Relay	4 (Maximum 88 digital I/Os)
	FC4A-C10R2	100-240V AC				
	FC4A-C16R2C	24V DC	16 (9 in/ 7 out)			
	FC4A-C16R2	100-240V AC				
	FC4A-C24R2C	24V DC	24 (14 in/ 10 out)			
	FC4A-C24R2	100-240V AC				

OT Touchscreens

PLCs

Automation Software

Power Supplies

Sensors

Communication

Barriers

MicroSmart CPU Part Numbers

Slim

Style	Part Number	Power	I/O Points	Input	Output	Maximum No. of Expansion Modules
	FC4A-D20RK1	24V DC	20 (12 in/8 out)	24V DC (Sink/Source)	6 Relays, 2 Transistor Sink	7 (Maximum 244 digital I/Os)
	FC4A-D20RS1				6 Relays, 2 Transistor Source	
	FC4A-D20K3				Transistor Sink	7 (Maximum 148 digital I/Os)
	FC4A-D20S3				Transistor Source	
	FC4A-D40K3		40 (24 in/16 out)		7 (Maximum 264 digital I/Os)	
	FC4A-D40S3					Transistor Source

01 Touchscreens

PLCs

Automation Software

Power Supplies

Sensors

Communication

Barriers

Digital I/O Expansion Modules

Key features:

- 15 modules to choose from
- Available with Screw or MIL connectors
- Easy snap-on
- Available 8, 16 or 32 point modules
- Up to 512 I/O can be configured in the Pentra and 264 I/O in the MicroSmart system

Input Modules

Style	Part Number	Input	Input Points	Terminal
	FC4A-N08A11	100-120V AC	8	Removable Screw Terminals
	FC4A-N08B1			
	FC4A-N16B1	24V DC	16	MIL Connector (ribbon cable)
	FC4A-N16B3			
	FC4A-N32B3			

I/O Touchscreens

PLCs

Automation Software

Power Supplies

Sensors

Communication

Barriers

Digital I/O Expansion Modules

OI Touchscreens

PLCs

Automation Software

Power Supplies

Sensors

Communication

Barriers

Output Modules



Style	Part Number	Output	Output Points	Terminal
	FC4A-R081	Relay	8	Removable Screw Terminals
	FC4A-R161		16	
	FC4A-T08K1	Transistor Sink	8	MIL Connector (ribbon cable)
	FC4A-T16K3		16	
	FC4A-T32K3		32	

Digital I/O Expansion Modules

Output Modules (cont.)

Style	Part Number	Output	Output Points	Terminal
	FC4A-T08S1		8	Removable Screw Terminals
	FC4A-T16S3	Transistor Source	16	MIL Connector (ribbon cable)
	FC4A-T32S3		32	

Combination I/O Modules

Style	Part Number	Input	Output	I/O Points	Terminal
	FC4A-M08BR1	24V DC (Sink/Source)	Relay	8 (4 in/4 out)	Removable Screw Terminals
	FC4A-M24BR2			24 (16 in/ 8 out)	Wire Spring Clamp

I/O Touchscreens

PLCs

Automation Software

Power Supplies

Sensors

Communication

Barriers

Analog I/O Expansion Modules

Key features:

- 9 different modules to choose from
- 0-10V, 4-20mA, RTD, Thermocouple, Thermistor inputs, 0-10V DC or -10V DC to 10V DC output
- 12 or 16-bit resolution
- Fast conversion time
- Maximum of 56 I/O can be configured in the MicroSmart Pentra system
- Easy to configure using a Macro instruction in WindLDR

Modules

Style	Part Number	I/O Points	Input	Output	Resolution	Terminal
	FC4A-J8C1	8 (8 inputs)		–	16-bit (0-50000)	
	FC4A-L03A1	3 (2 inputs, 1 output)	0-10V DC, 4-20mA	0-10V DC, 4-20mA	12-bit (0-4095)	
	FC4A-J2A1	2 (2 inputs)		–		Removable Screw Terminals
	FC4A-J4CN1	4 (4 inputs)	0-10V DC, 4-20mA, RTD, Thermocouple	–	16-bit (0-50000)	
	FC4A-L03AP1	3 (2 inputs, 1 output)	RTD, Thermocouple	0-10V DC, 4-20mA	12-bit (0-4095)	

OI Touchscreens

PLCs

Automation Software

Power Supplies



Sensors

Communication

Barriers

Analog I/O Expansion Modules

Modules (cont.)

Style	Part Number	I/O Points	Input	Output	Resolution	Terminal
	FC4A-J8AT1	8 (8 inputs)	Thermistor (NTC/PTC)	–	12-bit (0-4000)	
	FC4A-K2C1	2 (2 outputs)	–	-10 to 10V DC, 4-20mA	16-bit (0-50000)	Removable Screw Terminals
	FC4A-K1A1	1 (1 output)	–	0-10V DC, 4-20mA	12-bit (0-4095)	
	FC4A-K4A1	4 (4 outputs)				

Communication Modules

Web Server Module

Features:

- Easy to configure
- Comes with interface cable and Quick Start Guide

Part Numbers

Style	Part Number	Description
	FC4A-ENET	Web Server Module (includes cable and Quick Start Guide)

Style	Part Number	Description
	FC9Y-QS100-0	Quick Start Guide

I/O Touchscreens

PLCs

Automation Software

Power Supplies

Sensors

Communication

Barriers

Advanced PID for precision control

PID (Proportional Integral Derivative) is the most commonly used feedback control loop in industrial control systems. PID calculates an error value as the difference between a measured process variable and a desired set point. The controller then attempts to minimize the error by adjusting the process control. With MicroSmart Pentra PLCs, PID implementation can be deployed in two ways: integrated PID controls or a dedicated Process Control module, which can be mounted on the MicroSmart Pentra expansion bus.

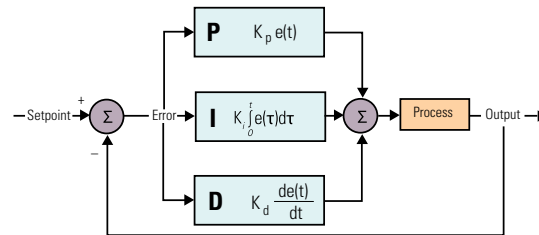

Advanced PID Control Module

A dedicated PID Control module is available for extreme stability and complex applications. This particular module has more functionalities than you will find in any other controller on the market. Independent of CPU scan time, the PID Control module does the work, reducing PLC scan time without taking up PLC memory space.

Advanced PID Control Module Part Numbers

Style	Part Number	Description
	FC5A-F2M2	PID Control Module with 2x analog inputs and 2x 4-20mA/non-contact voltage for SSR drive
	FC5A-F2MR2	PID Controls Module with 2x analog inputs and 2x Relay Outputs

PID Control Module Highlights:

- Precise, stable and accurate PID control with less than a 0.2% error
- Available in two models:
 - Built-in 2 analog inputs, 2 x 4-20mA/non-contact voltage for SSR drive
 - Built-in 2 analog inputs, 2 x relay outputs
- Each input individually configured to accept different signal types
- Up to seven modules can be mounted on the MicroSmart Pentra
- Maximum 14 PID loops with auto-tuning
- 14-bit resolution
- ARW (anti-reset windup)
- Accepts many different input types including:
 - Type K, J, R, S, B, E, T, C, PL-II and N thermocouples
 - RTD
 - 0-20 mA and 4-20 mA
 - 0-1V, 0-5V, 1-5V, and 0-10V DC
- Numerous control methods including:
 - Cascade
 - External set point
 - Heating and cooling control action
 - Difference input control



OT Touchscreens

PLCs

Automation Software

Power Supplies

Sensors

Communication

Barriers

Communication Modules
AS-Interface Module

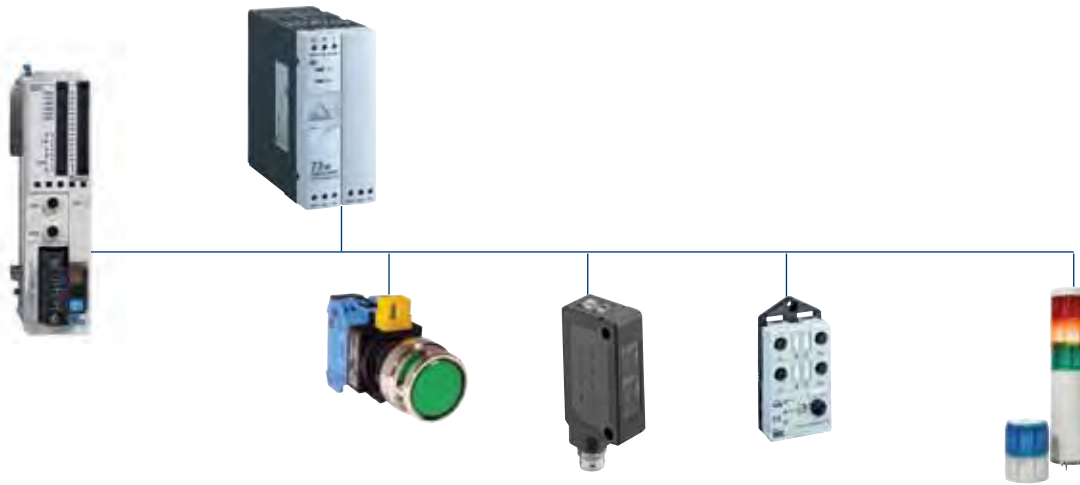

AS-Interface Master Module

Style	Part Number	Description
	FC4A-AS62M	MicroSmart AS-Interface Master Module

The Actuator Sensor-interface (AS-Interface) is the simplest and most cost-effective of the PLC-based, industrial-networking protocols. AS-Interface is a truly open, low-cost electromechanical connection system designed to operate over a two-wire cable carrying data and power over a distance of up to 100m. It is especially suitable for lower levels of plant automation where simple - often binary (On/Off) - field devices such as switches, sensors, and actuators need to interoperate in a local area automation network controlled by a PLC. IDEC supports this open technology.

IDEC offers a plug-in AS-Interface master module (as well as other AS-Interface devices, please see AS-Interface Communication section) that is easy to configure; it can also connect up to 62 slaves. With this technology, you'll reduce the amount of engineering needed, simplify wiring and enhance your operations; requiring less maintenance. With an average cost of savings of 15 to 40% compared with traditional cabling methods, using an IDEC AS-Interface module is the easy choice.

Master-Slave Principle

The AS-Interface master controls and monitors the status of slave devices connected to the AS-Interface bus. Normally, the AS-Interface master is connected to a PLC (sometimes called 'host') or a gateway.

range. A/B slaves have an address of 1A through 31A in the standard address range or 1B through 31B in the expanded address range. Among the A/B slaves, slaves with an address of

Various types of slave devices can be connected to the AS-Interface bus, including sensors, actuators, and remote I/O devices. Analog slaves can also be connected to process analog data. Slaves are available in standard slaves and A/B slaves. Standard slaves have an address of 1 through 31 in the standard address

1A through 31A are called A slaves, and slaves with an address of 1B through 31B are called B slaves. (see AS-Interface Communication section for more details)

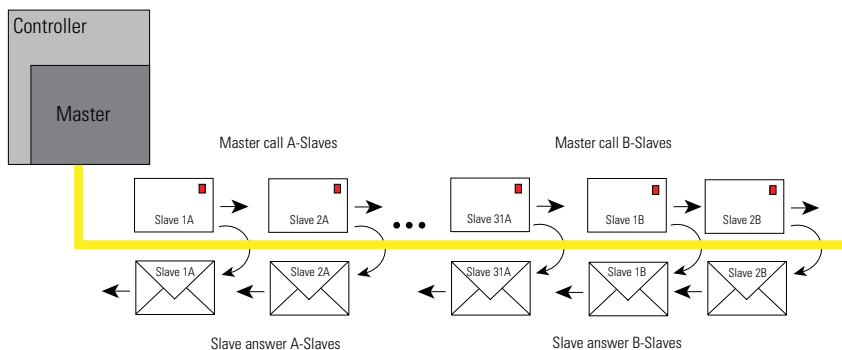

Communication Module

Style	Part Number	Description
	FC5A-SIF4	RS485 Communication Module for MicroSmart Pentra configure as port 3 to 7
	FC5A-SIF2	RS232 Communication Module for MicroSmart Pentra configure as port 3 to 7

Communicate with up to seven different serial devices

Only IDEC offers communication modules that enable you to configure up to seven serial devices! Now you can connect your operator interface, PC, barcode reader, RFID equipment, printer and more. Just imagine the possibilities.



Using the MicroSmart Pentra slim CPU, you can configure up to seven communication ports. Using the All-in-one MicroSmart Pentra you can communicate with up to five serial devices.



Optional Modules

Style	Part Number	Description	Usage
	FC4A-HPH1	HMI Base Module	For mounting HMI module and communication ports with slim model CPU module (HMI module is not included)
	FC4A-PH1	HMI Module	For displaying and changing operands
	FC4A-PM32	EEPROM memory cartridge	32KB EEPROM memory cartridge
	FC4A-PM64	EEPROM memory cartridge	64KB EEPROM memory cartridge
	FC4A-PM128	EEPROM memory cartridge	128KB EEPROM memory cartridge
	FC4A-PT1	Clock cartridge	Real-time clock cartridge

Communication Ports

Style	Part Number	Description	Terminal
	FC4A-PC1	RS232C	Mini DIN
	FC4A-PC2	RS485	Mini DIN
	FC4A-PC3	RS485	Screw Terminal

IO Touchscreens

PLCs

Automation Software

Power Supplies

Sensors

Communication

Barriers

OI Touchscreens

PLCs

Automation Software

Power Supplies

Sensors

Communication

Barriers

Communication Module — for Slim CPU

Style	Part Number	Description	Terminal
	FC4A-HPC1	RS232C	Mini DIN
	FC4A-HPC2	RS485	Mini DIN
	FC4A-HPC3	RS485	Screw Terminal

Expansion Power Supply Module

Style	Part Number	Description
	FC5A-EXM1M	Master Expansion Power Supply For MicroSmart Pentra
	FC5A-EXM1S	Slave Expansion Power Supply For MicroSmart Pentra
	FC5A-EXM2	Expansion Power Supply For MicroSmart Pentra

Expansion Power Supply System Configuration

FC5A-EXM2 (Expansion Interface Module)

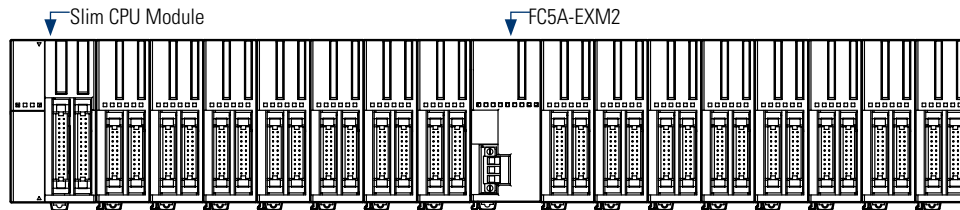

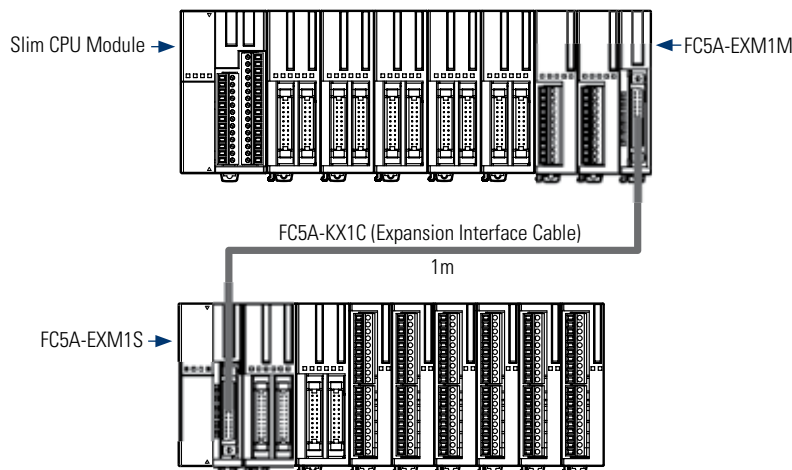

FC5A-EXM1M and FC5A-EXM1S (Expansion Interface Master & Slave Modules)



Cables

Communication Cables

Appearance	Part Number	Length	Expanded Description
	FC4A-KC4CA	5ft. (1.53m)	Programming cable (Maintenance/User Communication Mode selectable)
	FC4A-USB	6ft. (1.83m)	USB to Serial Converter
	FC4A-KC3C	0.33ft. (100mm)	Web Server Module interface cable
	HG9Z-XCM2A	6ft. (1.83m)	USB programming cable for embedded Ethernet CPU



Appearance	Part Number	Length	Expanded Description
	FC2A-KM1C	9.84 Ft. (3m)	Modem cable. Used to connect a modem to the MicroSmart RS232C port.
	FC2A-KP1C	9.84 Ft. (3m)	User communication cable. Used to connect RS232C equipment to the MicroSmart RS232C port.
	FC5A-KX1C	3.28 Ft. (1m)	MicroSmart Pentra expansion power supply interface cable. Used to connect expansion interface master and expansion slave modules.

MIL Connector Cables (use with Breakout Modules)

Use with	Part Number	Model	Length
CPU Module (26-wire) BX1D-S26A, BX1D-T26A	FC9Z-H050B26	Non-shielded	1.64ft. (0.5m)
	FC9Z-H100B26		3.28ft. (1m)
	FC9Z-H200B26		6.56ft (2m)
	FC9Z-H300B26	9.85ft. (3m)	Shielded
	FC9Z-H050A26	1.64ft. (0.5m)	
	FC9Z-H100A26	3.28ft. (1m)	
	FC9Z-H200A26	6.56ft (2m)	
	FC9Z-H300A26	9.85ft. (3m)	
	FC9Z-H100C26A	Shielded Single Connectors	5ft. (1.5m)

Use with	Part Number	Model	Length
I/O Expansion Modules (20-wire) BX1D-S20A, BX1D-T20A	FC9Z-H050B20	Non-shielded	1.64ft. (0.5m)
	FC9Z-H100B20		3.28ft. (1m)
	FC9Z-H200B20		6.56ft (2m)
	FC9Z-H300B20	9.85ft. (3m)	Shielded
	FC9Z-H050A20	1.64ft. (0.5m)	
	FC9Z-H100A20	3.28ft. (1m)	
	FC9Z-H200A20	6.56ft (2m)	
	FC9Z-H300A20	9.85ft. (3m)	
	FC9Z-H100C20A	Shielded Single Connectors	5ft. (1.5m)

Breakout Modules

Use with	Part Number	Description
26-wire MIL connector cable 	BX1D-S26A	26-terminal breakout module
	BX1D-T26A	26-terminal touch-down terminal breakout module
20-wire MIL connector cable 	BX1D-S20A	20-terminal breakout module
	BX1D-T20A	20-terminal touch-down terminal breakout module

IO Touchscreens

PLCs

Automation Software

Power Supplies

Sensors

Communication

Barriers

Accessories

01 Touchscreens

PLCs

Automation Software

Power Supplies

Sensors

Communication

Barriers

Part Number	Use with	Description
FC4A-PMT13	CPU module	13-position left-side terminal block for FC4A-D20RK1/-D20RS1 CPU
FC5A-PMT13		13-position left-side terminal block for FC5A-D16RK1/-D16RS1 CPU
FC4A-PMTS16		16-position right-side terminal block for FC4A-D20RS1 and FC5A-D16RS1 CPU
FC4A-PMTK16		16-position right-side terminal block for FC4A-D20RK1 and FC5A-D16RK1 CPU
FC4A-PMT11	I/O expansion modules	11-position terminal block for 8-pt I/O expansion modules
FC4A-PMT10		10-position terminal block for 16-pt I/O expansion modules
FC4A-PMC20		20-position connector socket for MIL connector I/O expansion modules
FC4A-PMC26		26-position connector socket for MIL connector CPU modules
FC4A-PSP1		Direct mounting strips for mounting on a panel
FC4A-PMAC2		Analog voltage input cable for slim CPU
FC4A-DS824-SW14		14-pt input simulator switch for 24 I/O CPU
FC4A-DS824-SW9		9-pt input simulator switch for 16 I/O CPU
FC4A-DS824-SW6		6-pt input simulator switch for 10 I/O CPU
FC9Y-B812-0A		MicroSmart user manual
FC9Y-B1138-0		MicroSmart Pentra user manual
SW1A-WIC		Automation Organizer Software Suite

RV8H Series 6mm Interface Relays

Key Features

- Space-saving 6mm width
- Only 70mm in height from DIN rail
- Gold-plated contacts
- Pre-assembled relay and DIN mount socket
- Universal screw terminals (flat and Phillips)
- Universal AC/DC socket with built-in surge suppression and green LED
- Lever for easy locking and removal of relay
- Wide input voltage range: 6 to 240V
- High dielectric strength and impulse withstand voltages
- Sensitive coil 170mW
- Reverse Polarity protected
- 400V AC maximum switching voltage
- 1500VA maximum switching power
- RoHS compliant



(when using combination of RV1H relay and SV1H socket)

Part Numbers

Coil Voltage	Part Number
DC	6V RV8H-L-D6
	9V RV8H-L-D9
	12V RV8H-L-D12
	18V RV8H-L-D18
	24V RV8H-L-D24
AC/DC	12V RV8H-L-AD12
	18V RV8H-L-AD18
	24V RV8H-L-AD24
	48V RV8H-L-AD48
	60V RV8H-L-AD60
	110V - 125V RV8H-L-AD110
220V - 240V RV8H-L-AD220	



Accessories

Item	Color	Part Number
Jumper (20 combs) ¹	Black	SV9Z-J20B
	Gray	SV9Z-J20W
	Blue	SV9Z-J20S
Spacer (circuit separator) ²	-	SV9Z-SAW
Marking plate (10 pcs)	-	SV9Z-PW10





1. Jumper combs come with 20 points, if shorter lengths are needed simply cut off the excess points.
2. Width of spacer: 2mm

Note: When using a cut jumper, please use a spacer on the cut side. For additional information see instruction sheet.

Standard stock models in bold.

Starter Kits and Solution Packages

MicroSmart Starter Kits

Item	Part Numbers	Controller	Power Supply	Software (Prog. Cables Included)
MicroSmart		MM-SMART-10	10 I/O FC4A-C10R2 CPU	–
		MM-SMART-16	16 I/O FC4A-C16R2 CPU	–
		MM-SMART-20	20 I/O FC4A-D20RK1 CPU	15W
		MM-SMART-24	24 I/O FC4A-C24R2 CPU	–
		MM-SMART-40	40 I/O FC4A-D40K3 Slim CPU	15W
MicroSmart Pentra		MM-PENTRA-16	16 I/Os FC5A-D16RS1 CPU	30W
		MM-PENTRA-24	24 I/Os FC5A-C24R2 CPU	–
		MM-PENTRA-12	12 I/Os FC5A-D12S1E Embedded Ethernet	30W

Automation Organizer Software Suite

MicroSmart Solution Packages



KIT-PENTRA-12-HG3G-AHP shown

Part Numbers	Operator Interface	Controller	Power Supply	Software (Prog. Cables Included)
KIT-PENTRA-24-HG1F	4.6" HG1F Mono	24 I/O FC5A-C24R2C CPU	60W	Automation Organizer Software Suite
KIT-PENTRA-12-HG1F	4.6" HG1F Mono	12 I/O FC5A-D12S1E Embedded Ethernet CPU	60W	
KIT-PENTRA-24-HG2G-M	5.7" HG2G Color TFT LCD	24 I/O FC5A-C24R2C CPU	60W	
KIT-PENTRA-12-HG2G-M	5.7" HG2G Color TFT LCD	12 I/O FC5A-D12S1E Embedded Ethernet CPU	60W	
KIT-PENTRA-24-HG2G-TE	5.7" HG2G Color TFT LCD	24 I/O FC5A-C24R2C CPU	60W	
KIT-PENTRA-12-HG2G-TE	5.7" HG2G Color TFT LCD	12 I/O FC5A-D12S1E Embedded Ethernet CPU	60W	
KIT-PENTRA-24-HG2G-HP	5.7" HG2G Color TFT LCD	24 I/O FC5A-C24R2C CPU	60W	
KIT-PENTRA-16-HG2G-HP	5.7" HG2G Color TFT LCD	16 I/O FC5A-D16RS1 CPU	60W	
KIT-PENTRA-12-HG2G-HP	5.7" HG2G Color TFT LCD	12 I/O FC5A-D12S1E Embedded Ethernet CPU	60W	
KIT-PENTRA-16-HG3G-8HP	8.4" HG3G Color TFT LCD	16 I/O FC5A-D16RS1 CPU	60W	
KIT-PENTRA-12-HG3G-8HP	8.4" HG3G Color TFT LCD	12 I/O FC5A-D12S1E Embedded Ethernet CPU	60W	
KIT-PENTRA-16-HG3G-AHP	10.4" HG3G Color TFT LCD	16 I/O FC5A-D16RS1 CPU	60W	
KIT-PENTRA-12-HG3G-AHP	10.4" HG3G Color TFT LCD	12 I/O FC5A-D12S1E Embedded Ethernet CPU	60W	
KIT-PENTRA-16-HG4G-HP	12.1" HG4G Color TFT LCD	16 I/O FC5A-D16RS1 CPU	60W	
KIT-PENTRA-12-HG4G-HP	12.1" HG4G Color TFT LCD	12 I/O FC5A-D12S1E Embedded Ethernet CPU	60W	



OI Touchscreens have black bezels. All packages come with Automation Organizer software suite and communication cables.

OI Touchscreens

PLCs

Automation Software

Power Supplies

Sensors

Communication

Barriers

Automation Organizer Suite Programming Software

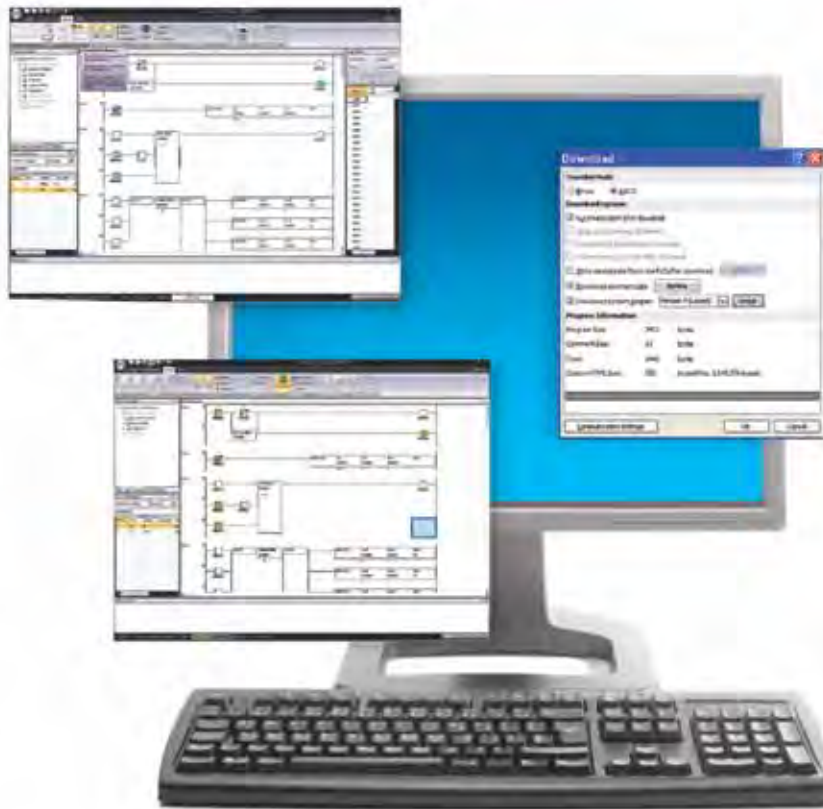

Automation Organizer (AO) is a powerful software suite containing PLC programming software (WindLDR), OI touchscreen configuration software (WindO/I-NV2) and system configuration software (WindCFG). AO boasts a completely new graphic user interface and redesigned menu icons. AO is a one-stop automation software package for IEC MicroSmart Pentra PLCs and IEC OI touchscreens, and is compatible with Windows XP, Vista (32 bit) and Windows 7 (32 and 64-bit).

Automation Organizer **WindLDR**

All IEC MicroSmart Pentra PLCs are programmable with WindLDR ladder logic software. This icon-driven programming tool combines logic and intuition with an incredibly easy-to-use interface to allow you to take advantage of MicroSmart features. Even without ladder program experience, you can use the built-in editors, shortcuts and debuggers to configure programs. WindLDR is an excellent, long-term investment for your control solutions.

Simulation Mode

WindLDR allows you to simulate ladder programs with built-in Simulation mode. You can easily test and verify functionality of your ladder program without actual hardware.

Online Editing

Shutting down your PLC for minor changes can be a major hassle, so WindLDR allows you to edit and download programs without interrupting PLC operation. You can write new values to counters, timers and registers at any time without switching between editor mode (for programming) and monitor mode.

Firmware Download

With WindLDR version 6.4 or later, you have the option to upgrade or downgrade your CPU system program. It's as simple as clicking on the checkbox in the Download dialog box. Now you can easily update your PLC system firmware with the click of a button.

Automation Organizer **WindO/I-NV2**

WindO/I-NV2 software is the programming tool available for all IEC OI touchscreens. It is used to create projects or programs that can display information from a PLC, process status, or can be used to input data with virtual switches or keypads to make changes to a process. The objects are extremely easy to configure with the help of step-by-step navigation. It lets you quickly create colorful graphical screens in no time using drop-down menus and intuitive drag and drop functionality for the objects. A workspace is available to help you organize and manage projects, objects and screens.

Automation Organizer **WindCFG**

WindCFG is a system layout and configuration tool for IEC PLCs and OI touchscreens. Using WindCFG, you can create a visual layout of the system design and basic configuration of your PLC and OI touchscreens.

FREE Upgrades

The Automation Organizer suite comes with free lifetime upgrades. Once you make the initial purchase, upgrades are absolutely free.

Part Number

Part Number	Description
SW1A-W1C	Automation Organizer software suite

For more information, see page 121.

OI Touchscreens

PLCs

Automation Software

Power Supplies

Sensors

Communication

Barriers

Specifications

Slim Type

Model	FC5A-D12K1E FC5A-D12S1E	FC5A-D16RK1 FC5A-D16RS1	FC5A-D32K3 FC5A-D32S3	FC4A-D20K3 FC4A-D20S3	FC4A-D20RK1 FC4A-D20RS1	FC4A-D40K3 FC4A-D40S3
Rated Power Voltage	24V DC					
Allowable Voltage Range	20.4 to 26.4V DC (including ripple)					
Maximum Input Current	700 mA (26.4V DC) ¹			560 mA (26.4V DC) ¹	700 mA (26.4V DC) ¹	
Maximum Power Consumption	19W (26.4V DC) ¹			14W (26.4V DC) ¹	17W (26.4V DC) ¹	
Allowable Momentary Power Interruption	10 ms (at 24V DC)					
Dielectric Strength	Between power and ⚡ terminals: 500V AC, 1 minute Between I/O and ⚡ terminals: 500V AC, 1 minute					
Insulation Resistance	Between power and ⚡ terminals: 10 MΩ minimum (500V DC megger) Between I/O and ⚡ terminals: 10 MΩ minimum (500V DC megger)					
Noise Resistance	DC power terminals: 1.0 kV, 50 ns to 1 μs I/O terminals (coupling clamp): 1.5 kV, 50 ns to 1 μs					
Inrush Current	50A maximum (24V DC)					
Power Supply Wire	UL1015, AWG22, UL1007 AWG18					
Operating Temperature	0 to 55°C					
Storage Temperature	-25 to +70°C (no freezing)					
Relative Humidity	Level RH1 (IEC61131-2), 10 to 95% (no condensation)					
Altitude	Operation: 0 to 2,000m, Transport: 0 to 3,000m					
Pollution Degree	2 (IEC60664-1)					
Corrosion Immunity	Free from corrosive gases					
Degree of Protection	IP20 (IEC60529)					
Grounding Wire	UL1015, AWG22, UL1007, AWG18					
Vibration Resistance	When mounted on a DIN rail or panel surface: 5 to 8.4 Hz amplitude 3.5 mm, 8.4 to 150 Hz acceleration 9.8 m/s ² (1G), 2 hours per axis on each of three mutually perpendicular axes (IEC61131-2)					
Shock Resistance	147 m/s ² (15G), 11 ms duration, 3 shocks per axis on three mutually perpendicular axes (IEC61131-2)					
Weight	200g	230g	190g	140g	185g	180g

 1. CPU module + 7 I/O modules

I/O Touchscreens

PLCs

Automation Software

Power Supplies

Sensors

Communication

Barriers

All-in-One Type

Model	FC5A-C10R2 FC5A-C10R2C FC5A-C10R2D	FC5A-C16R2 FC5A-C16R2C FC5A-C16R2D	FC5A-C24R2 FC5A-C24R2C FC5A-C24R2D	FC4A-C10R2 FC4A-C10R2C	FC4A-C16R2 FC4A-C16R2C	FC4A-C24R2 FC4A-C24R2C
Rated Power Voltage	AC power type: 100 to 240V AC, DC power type: 24V DC, 12V DC					
Allowable Voltage Range	AC power type: 85 to 264V AC, 24V DC power type: 20.4 to 28.8V DC (including ripple), 12V DC type: 10.2 to 18.0V DC					
Rated Power Frequency	AC power type: 50/60 Hz (47 to 63 Hz)					
Maximum Input Current	250 mA (85V AC) 160 mA (24V DC)	300 mA (85V AC) 190 mA (24V DC)	450 mA (85V AC) ¹ 360 mA (24V DC) ²	250 mA (85V AC) 160 mA (24V DC)	300 mA (85V AC) 190 mA (24V DC)	450 mA (85V AC) ¹ 360 mA (24V DC) ²
Maximum Power Consumption	AC Power FC5A-C10R2/FC4A-C10R2: 30VA (264V AC), 20VA (100V AC) ³ FC5A-C16R2/FC4A-C16R2: 31VA (264 V AC), 22VA (100V AC) ³ FC5A-C24R2/FC4A-C24R2: 40VA (264V AC), 33VA (100V AC) ¹					
	DC Power FC5A-C10R2C/FC4A-C10R2C: 3.9W (24V DC) *5 FC5A-C10R2D: 2.8W (12V DC) ⁴ FC5A-C16R2C/FC4A-C16R2C: 4.6W (24V DC) *5 FC5A-C16R2D: 3.4W (12V DC) ⁴ FC5A-C24R2C/FC4A-C24R2C: 8.7W (24V DC) *3 FC5A-C24R2D: 4.2W (12V DC) ⁴					
Allowable Momentary Power Interruption	10 ms (rated power voltage)					
Dielectric Strength	Between power and ⊕ or ⊖ terminals: 1,500V AC, 1 minute Between I/O and ⊕ or ⊖ terminals: 1,500V AC, 1 minute					
Insulation Resistance	Between power and ⊕ or ⊖ terminals: 10 MΩ minimum (500V DC megger) Between I/O and ⊕ or ⊖ terminals: 10 MΩ minimum (500V DC megger)					
Noise Resistance	AC power terminals: 1.5 kV, 50 ns to 1 μs DC power terminals: 1.0 kV, 50 ns to 1 μs I/O terminals (coupling clamp): 1.5 kV, 50 ns to 1 μs					
Inrush Current	FC5A-C10R2/FC5A-C10R2C/FC5A-C16R2/ FC5A-C16R2C: 35A FC5A-C10R2D/FC5A-C16R2D: 20A		FC5A-C24R2/ FC5A-C24R2C: 40A FC5A-C24R2D: 20A	35A		40A
Power Supply Wire	UL1015 AWG22, UL1007 AWG18					
Operating Temperature	0 to 55°C					
Storage Temperature	-25 to +70°C (no freezing)					
Relative Humidity	Level RH1 (IEC61131-2), 10 to 95% (no condensation)					
Altitude	Operation: 0 to 2,000m, Transport: 0 to 3,000m					
Pollution Degree	2 (IEC60664-1)					
Corrosion Immunity	Free from corrosive gases					
Degree of Protection	IP20 (IEC60529)					
Ground	Ground resistance 100Ω (max.)					
Grounding Wire	UL1007, AWG16					
Vibration Resistance	When mounted on a DIN rail or panel surface: 5 to 8.4 Hz amplitude 3.5 mm, 8.4 to 150 Hz acceleration 9.8 m/s ² (1G), 2 hours per axis on each of three mutually perpendicular axes (IEC61131-2)					
Shock Resistance	147 m/s ² (15G), 11 ms duration, 3 shocks per axis on three mutually perpendicular axes (IEC61131-2)					
Weight	AC type: 230g DC type: 240g	AC type: 250g DC type: 260g	AC type: 305g DC type: 310g	AC type: 230g DC type: 240g	AC type: 250g DC type: 260g	AC type: 305g DC type: 310g



1. CPU module (including 250 mA sensor power) + 4 I/O modules
2. CPU module + 4 I/O modules
3. CPU module (including 250 mA sensor power)
4. CPU module

01 Touchscreens

PLCs

Automation Software

Power Supplies

Sensors

Communication

Barriers

Slim Type Function Specifications

Model		FC5A-D12K1E FC5A-D12S1E	FC5A-D16RK1 FC5A-D16RS1	FC5A-D32K3 FC5A-D32S3	FC4A-D20K3 FC4A-D20S3	FC4A-D20RK1 FC4A-D20RS1	FC4A-D40K3 FC4A-D40S3
Control System		Stored program system					
Instruction Words		42 basic			35 basic		
		152 advanced	126 advanced	130 advanced	53 advanced	72 advanced	
Program Capacity ¹		127.8 KB (21,300 steps)	62.4 KB (10,400 steps)		27 KB (4,500 steps)	31.2 KB (5,200 steps) ²	
User Program Storage		Flash ROM (10,000 times rewritable)		EEPROM (10,000 times rewritable)			
Processing Time	Basic Instruction	83 μs (1,000 steps)			1.65 ms (1,000 steps)		
	END Processing ³	0.35 ms			0.64 ms		
Expandable I/O Modules		7 modules + additional 8 modules using the expansion interface module			7 modules		
I/O Points	Input	8	Expansion: 224 Additional: 256	8	Expansion: 224 Additional: 256	16	Expansion: 224 Additional: 256
	Output	4	8	8	16	16	Expansion: 224
Internal Relay		2,048 points			1,024 points		
Shift Register		256 points			128 points		
Data Register		42,000 points	42,000 points ⁴		1,300 points		
Expansion Data Register		6,000 points			—	6,000 points	
Counter		256 points			100 points		
Timer (1-sec, 100-ms, 10-ms, 1-ms)		256 points			100 points		
RAM Backup	Backup Data	Internal relay, shift register, counter, data register, expansion data register					
	Backup Duration	Approx. 30 days (typical) at 25°C after backup battery fully charged					
	Battery	Lithium secondary battery					
	Charging Time	Approx. 15 hours for charging from 0% to 90% of full charge					
	Battery Life	5 years in cycles of 9-hour charging and 15-hour discharging					
	Replaceability	Not possible to replace battery					
Self-diagnostic Function		Power failure, watchdog timer, data link connection, user program ROM sum check, timer/counter preset value sum check, user program RAM sum check, keep data, user program syntax, user program writing, CPU module, clock IC, I/O bus initialize, user program execution					
Input Filter		Without filter, 3 to 15 ms (selectable in increments of 1 ms)					
Catch Input/Interrupt Input		Four inputs (I2 and I5) Minimum turn on pulse width: 40 μs maximum Minimum turn off pulse width: 150 μs maximum (I3 and I4) Minimum turn on pulse width: 5 μs maximum Minimum turn off pulse width: 5 μs maximum			Four inputs (I2 through I5) Minimum turn on pulse width: 40 μs maximum Minimum turn off pulse width: 150 μs maximum		
High-speed Counter	Maximum Counting Frequency and High-speed Counter Points	Total 4 points Single/two-phase selectable: 100 kHz (2 points) Single-phase: 100 kHz (2 points)			Total 4 points Single/two-phase selectable: 20 kHz (2 points) Single-phase: 5 kHz (2 points)		
	Counting Range	0 to 4,294,967,295 (32 bits)			0 to 65,535 (16 bits)		
	Operation Mode	Rotary encoder mode and adding counter mode					
Analog Potentiometer	Quantity	1 point					
	Data Range	0 to 255					
Analog Voltage Input	Quantity	1 point					
	Input Voltage Range	0 to 10V DC					
	Input Impedance	Approx. 100 kΩ					
	Data Range	0 to 255 (8 bits)					
Pulse Output	Quantity	3 points	2 points	3 points	2 points		
	Maximum Frequency	100 kHz			20 kHz		

 Note: The maximum number of relay outputs that can be turned on simultaneously is 54 including those on the CPU module. Modem communication not possible on FC5A-D12K1E/D12S1E modules.

- 1 step equals 6 bytes.
- Expandable up to 62.4 KB when a memory cartridge is used.
- Not including expansion I/O service time, clock function processing time, data link processing time, and interrupt processing time.
- Extra data registers D10000 through D49999 are enabled using WindLDR Function Area Settings, then run-time program download cannot be used.
- Maintenance communication (change monitor device values, upload/download user programs, download system program)
- Maintenance communication, user communication, modem communication, data link, Modbus ASCII/RTU master/slave communication (FC5A only).

Slim Type Function Specifications (con't)

01 Touchscreens

PLCs

Automation Software

Power Supplies

Sensors

Communication

Barriers

Model		FC5A-D12K1E FC5A-D12S1E	FC5A-D16RK1 FC5A-D16RS1	FC5A-D32K3 FC5A-D32S3	FC4A-D20K3 FC4A-D20S3	FC4A-D20RK1 FC4A-D20RS1	FC4A-D40K3 FC4A-D40S3
Ethernet Port	Ethernet Specifications	Electrical Characteristics: Complies with IEEE802.3 Transmission Speed: 10BASE-T/100BASE-TX					
	Ethernet Interface	RJ45					
	User Web Page Area	1 MB					
	Compliant Browser	Internet Explorer 7 and 8, Firefox 3					
	Protocol	Data Link Layer: IP, ARP Network Layer: UDP, TCP, ICMP Application Layer: SMTP, DHCP, HTTP, NBNS, DNS, SNMP					
	Function (see table next page)	Web server, Send email, PING, Maintenance communication server, Modbus TCP server/client, User communication server/client, SNMP					
Port 1	USB mini-B (CDC class) Maintenance Communication ⁵			RS232C – maintenance communication, user communications, Modbus slave ASCII/RTU communication (FC5A only)			
Port 2 Communication Adapter/Module (option) ⁶				Possible			
Clock Cartridge (option)				Possible			
Memory Cartridge (option)				Possible			
HMI Module (option)				Possible			

-  Note: The maximum number of relay outputs that can be turned on simultaneously is 54 including those on the CPU module. Modem communication not possible on FC5A-D12K1E/D12S1E modules.
1. 1 step equals 6 bytes.
 2. Expandable up to 62.4 KB when a memory cartridge is used.
 3. Not including expansion I/O service time, clock function processing time, data link processing time, and interrupt processing time.
 4. Extra data registers D10000 through D49999 are enabled using WindLDR Function Area Settings, then run-time program download cannot be used.
 5. Maintenance communication (change monitor device values, upload/download user programs, download system program)
 6. Maintenance communication, user communication, modem communication, data link, Modbus ASCII/RTU master/slave communication (FC5A only).

All-in-One Type Function Specifications

Model	FC5A-C10R2 FC5A-C10R2C FC5A-C10R2D	FC5A-C16R2 FC5A-C16R2C FC5A-C16R2D	FC5A-C24R2 FC5A-C24R2C FC5A-C24R2D	FC4A-C10R2 FC4A-C10R2C	FC4A-C16R2 FC4A-C16R2C	FC4A-C24R2 FC4A-C24R2C
Control System	Stored program system					
Instruction Words	42 basic			35 basic		
Program Capacity ¹	103 advanced 13.8 KB (2,300 steps)	103 advanced 27 KB (4,500 steps)	115 advanced 54 KB (9,000 steps)	38 advanced 4.8 KB (800 steps)	40 advanced 15 KB (2,500 steps)	48 advanced 27 KB (4,500 steps)
User Program Storage	EEPROM (10,000 times rewritable)					
Processing Time	Basic Instruction	1.16 ms (1,000 steps)			1.65 ms (1,000 steps)	
	END Processing ²	0.64 ms			0.64 ms	
Expandable I/O Module	—			4 modules		4 modules
I/O Points	Input	6	9	14	Expansion: 6	9
	Output	4	7	10	64 ³	4
Internal Relay	2,048 points			256 points	1,024 points	
Shift Register	128 points			64 points	128 points	
Data Register	2,000 points			400 points	1,300 points	
Expansion Data Register	—					
Counter	256 points			32 points	100 points	
Timer (1-sec, 100-ms, 10-ms, 1-ms)	256 points			32 points	100 points	
RAM Backup	Backup Data	Internal relay, shift register, counter, data register				
	Backup Duration	Approx. 30 days (typical) at 25°C after backup battery fully charged				
	Battery	Lithium secondary battery				
	Charging Time	Approx. 15 hours for charging from 0% to 90% of full charge				
	Battery Life	5 years in cycles of 9-hours charging and 15-hours discharging				
Replaceability	Not possible to replace battery					
Self-diagnostic Function	Power failure, watchdog timer, data link connection, user program EEPROM sum check, timer/counter preset value sum check, user program RAM sum check, keep data, user program syntax, user program writing, CPU module, clock IC, I/O bus initialize, user program execution					
Input Filter	Without filter, 3 to 15 ms (selectable in increments of 1 ms)					
Catch Input/Interrupt Input	Four inputs (I2 through I5) Minimum turn on pulse width: 40 µs maximum Minimum turn off pulse width: 150 µs maximum					
High-speed Counter	Maximum Counting Frequency and High-speed Counter Points	Total 4 points Single/two-phase selectable: 50 kHz (1 point) Single-phase: 5 kHz (3 points)			Total 4 points Single/two-phase selectable: 20 kHz (1 point) Single-phase: 5 kHz (3 points)	
	Counting Range	0 to 65,535 (16 bits)				
	Operation Mode	Rotary encoder mode and adding counter mode				
Analog Potentiometer	Quantity	1 point		2 points	1 point	
	Data Range	0 to 255				
Analog Voltage Input	Quantity	—				
	Input Voltage Range	—				
	Input Impedance	—				
Pulse Output	Quantity	—				
	Max. Frequency	—				
Sensor Power Supply (AC Power Type Only)	Output Voltage/Current	24V DC (+10% to -15%), 250 mA				
	Overload Detection	Not available				
	Isolation	Isolated from the internal circuit				
Port 1	RS232C – maintenance communication, user communications, Modbus ASCII/RTU slave communication (FC5A only)					
Port 2 Communication Adapter (option) ⁴	Possible	Possible	Possible	—	Possible	Possible
Clock Cartridge (option)	Possible	Possible	Possible	Possible	Possible	Possible
Memory Cartridge (option)	Possible	Possible	Possible	Possible	Possible	Possible
HMI Module (option)	Possible	Possible	Possible	Possible	Possible	Possible



1. 1 step equals 6 bytes.
 2. Not including expansion I/O service time, clock function processing time, data link processing time, and interrupt processing time.
 3. Expansion modules cannot be connected to FC5A-C24R2D.
 4. Maintenance communication, user communication, Modem communication, data link, Modbus ASCII/RTU master/slave communication (FC5A only).
 Note: The maximum number of relay outputs that can be turned on simultaneously is 33 including those on the CPU module.

I/O Touchscreens

PLCs

Automation Software

Power Supplies

Sensors

Communication

Barriers

Communication Port (Port 1) Specifications

CPU Module	FC5A-D12K1E/D12S1E	Slim CPU	All-in-One CPU
Standards	USB 2.0	EIA RS232C	
Maximum Baud Rate	USB 2.0	FC5A: 57,600 bps (maintenance communication) FC4A: 19,200 bps (maintenance communication)	
Cable	HG9Z-XCM2A	FC2A-KC4C, FC2A-KP1C, FC4A-KC1C, FC4A-KC2C	
Isolation between Internal Circuit and Communication Port	Not isolated	Not isolated	

Slim Type Input Specifications

Model	FC5A-D12K1E FC5A-D12S1E	FC4A-D20K3 FC4A-D20S3	FC5A-D16RK1 FC5A-D16RS1	FC4A-D20RK1 FC4A-D20RS1	FC5A-D32K3 FC5A-D32S3	FC4A-D40K3 FC4A-D40S3
Input Points	8 (8/1 common)	12 (12/1 common)	8 (8/1 common)	12 (12/1 common)	16 (8/1 common)	24 (12/1 common)
Rated Input Voltage	24V DC sink/source input signal					
Input Voltage Range	20.4 to 26.4V DC					
Rated Input Current	FC5A	I0, I1, I3, I4, I6, I7: I2, I5, I10 to I17:	4.5 mA/point (24V DC) 7 mA/point (24V DC)			
	FC4A	I0, I1, I6, I7: I2 to I5, I10 to I27:	5 mA/point (24V DC) 7 mA/point (24V DC)			
Input Impedance	FC5A	I0, I1, I3, I4, I6, I7: I2, I5, I10 to I17:	4.9 kΩ 3.4 kΩ			
	FC4A	I0, I1, I6, I7: I2 to I5, I10 to I27:	5.7 kΩ 3.4 kΩ			
Turn ON Time	FC5A	I0, I1, I3, I4, I6, I7: I2 and I5: I10 to I17:	5 μs + filter value 35 μs + filter value 40 μs + filter value			
	FC4A	I0, I1, I6, I7: I2 to I5: I10 to I27:	35 μs + filter value 35 μs + filter value 40 μs + filter value			
Turn OFF Time	FC5A	I0, I1, I3, I4, I6, I7: I2 and I5: I10 to I17:	5 μs + filter value 150 μs + filter value 150 μs + filter value			
	FC4A	I0, I1, I6, I7: I2 to I5: I10 to I27:	45 μs + filter value 150 μs + filter value 150 μs + filter value			
Connector	On Mother Board	MC1.5/16-G-3.81BK (Phoenix Contact)	FL26A2MA (Oki Electric Cable)	MC1.5/13-G-3.81BK (Phoenix Contact)	FL26A2MA (Oki Electric Cable)	
	Insertion Durability	100 times minimum				
Isolation	Between input terminals: Optocoupler isolated Internal circuit: Not isolated					
Input Type	Type 1 (IEC61131-2)					
External Load for I/O Interconnection	Not needed					
Single Determination Method	Static					
Effect of Improper Input Connection	Both sinking and sourcing input signals can be connected, therefore reverse connection does not cause permanent damage. If any input exceeding the rated value is applied, permanent damage may be caused.					
Cable Length	3m in compliance with electromagnetic immunity					

OI Touchscreens

PLCs

Automation Software

Power Supplies

Sensors

Communication

Barriers

All-in-One Type Input Specifications

Model	FC5A-C10R2 FC5A-C10R2C	FC5A-C16R2 FC5A-C16R2C	FC5A-C24R2 FC5A-C24R2C	FC5A-C10R2D	FC5A-C16R2D	FC5A-C24R2D
	FC4A-C10R2 FC4A-C10R2C	FC4A-C16R2 FC4A-C16R2C	FC4A-C24R2 FC4A-C24R2C	—	—	—
Input Points	6 (6/1 common)		9 (9/1 common)	14 (14/1 common)		6 (6/1 common)
Rated Input Voltage	24V DC sink/source input signal			12V DC sink/source input signal		
Input Voltage Range	20.4 to 28.8V DC			10.2 to 18.0V DC		
Rated Input Current	FC5A	I0 and I1: I2 to I7, I10 to I15:	6.4 mA/point 7 mA/point (24V DC)	I0 and I1: I2 to I7, I10 to I15:	6 mA 6 mA	
	FC4A	I0 and I1: I2 to I7, I10 to I15:	11 mA 7 mA/point (24V DC)			
Input Impedance	FC5A	I0 and I1: I2 to I7, I10 to I15:	3.7 kΩ 3.4 kΩ	I0 and I1: I2 to I7, I10 to I15:	1.8 kΩ 2.0 kΩ	
	FC4A	I0 and I1: I2 to I7, I10 to I15:	2.1 kΩ 3.4 kΩ			
Turn ON Time	FC5A	I0 and I1: I2 to I5: I6, I7, I10 to I15:	2 μs + filter value 35 μs + filter value 40 μs + filter value	I0 and I1: I2 to I5: I6, I7, I10 to I15:	2 μs + filter value 35 μs + filter value 40 μs + filter value	
	FC4A	I0 and I1: I2 to I5: I6, I7, I10 to I15:	35 μs + filter value 35 μs + filter value 40 μs + filter value			
Turn OFF Time	FC5A	I0 and I1: I2 to I5: I6, I7, I10 to I15:	16 μs + filter value 150 μs + filter value 150 μs + filter value	I0 and I1: I2 to I5: I6, I7, I10 to I15:	16 μs + filter value 150 μs + filter value 150 μs + filter value	
	FC4A	I0 and I1: I2 to I5: I6, I7, I10 to I15:	45 μs + filter value 150 μs + filter value 150 μs + filter value			
Isolation	Between input terminals: Optocoupler isolated Internal circuit: Not isolated					
Input Type	Type 1 (IEC61131-2)					
External Load for I/O Interconnection	Not needed					
Single Determination Method	Static			—		
Effect of Improper Input Connection	Both sinking and sourcing input signals can be connected, therefore reverse connection does not cause permanent damage. If any input exceeding the rated value is applied, permanent damage may be caused.					
Cable Length	3m in compliance with electromagnetic immunity					

OT Touchscreens

PLCs

Automation Software

Power Supplies

Sensors

Communication

Barriers

Transistor Sink and Source Output Specifications

Model		FC5A-D12K1E FC5A-D12S1E	—	FC5A-D16RK1 FC5A-D16RS1	FC5A-D32K3 FC5A-D32S3
		—	FC4A-D20RK1 FC4A-D20RS1	—	FC4A-D40K3 FC4A-D40S3
Transistor Output Points		4 (4/1 common)		2 (2/1 common)	
Output Type	Transistor Sink	FC5A-D12K1E/D16RK1/D32K3 FC4A-D20K3/D20RK1/D40K3			
	Transistor Source	FC5A-D12S1E/D16RS1/D32S3 FC4A-D20S3/D20RS1/D40S3			
Rated Load Voltage		24V DC			
Operating Load Voltage Range		20.4 to 28.8V DC			
Rated Load Current		0.3A per output point			
Maximum Load Current		1A per common			
Voltage Drop (ON Voltage)		1V maximum (voltage between COM and output terminals when output is on)			
Inrush Current		1A			
Leakage Current		0.1 mA maximum			
Clamping Voltage		39V±1V			
Maximum Lamp Load		8W			
Inductive Load		L/R = 10 ms (28.8V DC, 1 Hz)			
External Current Draw		Sink output: 100 mA maximum, 24V DC (power voltage at the +V terminal) Source output: 100 mA maximum, 24V DC (power voltage at the -V terminal)			
Isolation		Between output terminal and Internal circuit: Photocoupler isolated Between output terminals: Not isolated			
Connector on Mother Board		MC1.5/16-G-3.81BK (Phoenix Contact)	FL26A2MA (Oki Electric Cable)	MC1.5/16-G-3.81BK (Phoenix Contact)	FL26A2MA (Oki Electric Cable)
Connector Insertion/ Removal Durability		100 times minimum			
Output Delay	Turn ON Time	FC5A	Q0 to Q2:	5 μs max.	
			Q3 to Q7, Q10 to Q17:	300 μs max.	
	Turn OFF Time	FC4A	Q0, Q1:	5 μs max.	
			Q2 to Q7, Q10 to Q17:	300 μs max.	
	FC5A	Q0 to Q2:	5 μs max.		
		Q3 to Q7, Q10 to Q17:	300 μs max.		
		FC4A	Q0, Q1:	5 μs max.	
			Q2 to Q7, Q10 to Q17:	300 μs max.	

OI Touchscreens

PLCs

Automation Software

Power Supplies

Sensors

Communication

Barriers

Relay Output Specifications

Model	FC5A-C10R2 FC5A-C10R2C FC5A-C10R2D	FC5A-C16R2 FC5A-C16R2C FC5A-C16R2D	FC5A-C24R2 FC5A-C24R2C FC5A-C24R2D	FC5A-D16RK1 FC5A-D16RS1
	FC4A-C10R2 FC4A-C10R2C	FC4A-C16R2 FC4A-C16R2C	FC4A-C24R2 FC4A-C24R2C	FC4A-D20RK1 FC4A-D20RS1
Relay Output Points	4	7	10	6
Output Points per Common Line	COM0	3	4	—
	COM1	1	2	3
	COM2	—	1	2
	COM3	—	—	1
Output Type	1NO			
Maximum Load Current	2A per point 8A per common line			
Minimum Switching Load	1 mA/ 5V DC (reference value)			
Initial Contact Resistance	30 mΩ maximum			
Electrical Life	100,000 operations minimum (rated load 1,800 operations/hour)			
Mechanical Life	20,000,000 operations minimum (no load 18,000 operations/hour)			
Rated Load	240V AC/2A (resistive load, inductive load cos $\theta = 0.4$) 30V DC/2A (resistive load, inductive load L/R =7 ms)			
Dielectric Strength	Between output and ⏏ terminals:		1,500V AC, 1 minute	
	Between output terminal and internal circuit:		1,500V AC, 1 minute	
	Between output terminals (COMs):		1,500V AC, 1 minute	
Connector on Mother Board	—			*1
Connector Insertion/ Removal Durability	—			100 times minimum



1. MC1.5/16-G-3.81BK (Phoenix Contact)

**Input Usage Limits
Slim CPU**

FC5A-D16RK1/D16RS1
FC5A-D12K1E/D12S1E

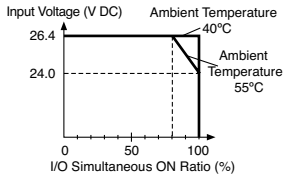

FC5A-D32K3/D32S3
FC4A-D40K3/D40S3

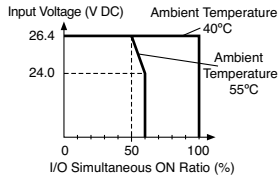

FC4A-D20K3/D20S3

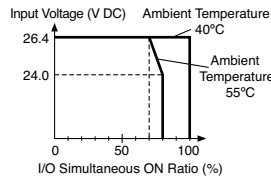

FC4A-D20RK1/D20RS1

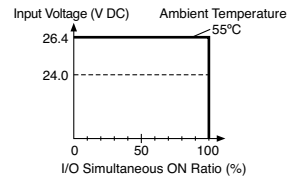

All-in-One CPU

FC5A-C10R2
FC5A-C10R2C
FC4A-C10R2
FC4A-C10R2C

FC5A-C16R2
FC5A-C16R2C
FC4A-C16R2
FC4A-C16R2C

FC5A-C24R2
FC5A-C24R2C
FC4A-C24R2
FC4A-C24R2C

CAUTION: When using at an operating ambient temperature above 40°C, reduce the input voltage or the quantity of I/O points that turn on simultaneously.

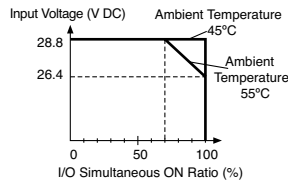
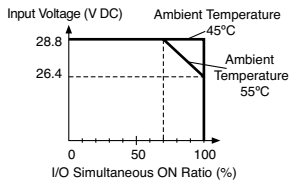
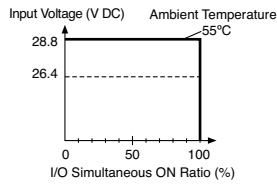

Input Internal Circuit

Slim CPU

FC5A: I0, I1, I3, I4, I6, I7
FC4A: I0, I1, I6, I7

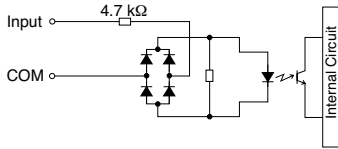

All-in-One CPU

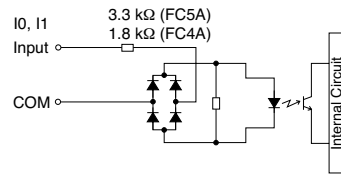

FC5A All-in-One CPU 12V DC Type

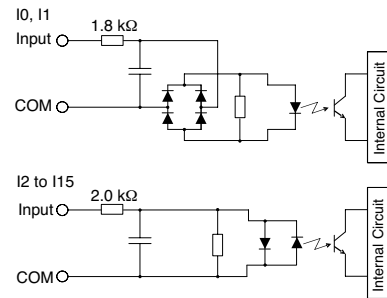

FC5A: I2, I5, I10 to I17
FC4A: I2 to I5, I10 to I27

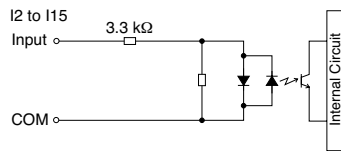
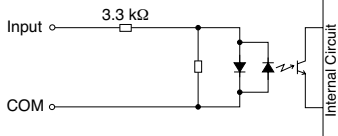

Output Internal Circuit

Slim CPU

Sink Output

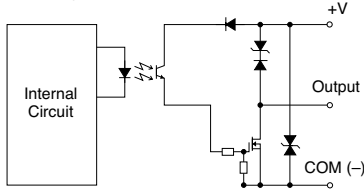

Source Output

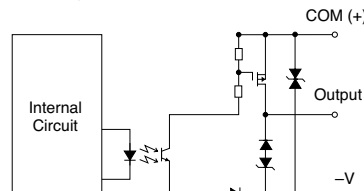

Communication Adapter/Module Specifications

Model	FC4A-PC1 FC4A-HPC1	FC4A-PC2 FC4A-HPC2	FC4A-PC3 FC4A-HPC3	
Standards	EIA RS232C	EIA RS485	EIA RS485	
Maximum Baud Rate	FC5A: 57,600 bps ¹ FC4A: 19,200 bps	FC5A: 57,600 bps ¹ FC4A: 19,200 bps	FC5A: 57,600 bps ¹ FC4A: 19,200 bps (38,400 bps ²)	
Maintenance Communication	Possible	Possible	Possible	
User Communication	Possible	Possible ³	Possible ³	
Data Link Communication	—	Possible	Possible	
Half-duplex Communication	—	Possible	Possible	
Maximum Cable Length	Special cable ⁴	Special cable ⁵	200m	
Quantity of Slave Stations	—	31	31	
Isolation between Internal Circuit and Communication Port	Not isolated			
RS485 Cable	—		Cable	Twisted-pair shielded cable with a minimum core wire of 0.3 mm ²
			Conductor Resistance	85 Ω/km maximum
			Shield Resistance	20 Ω/km maximum

- 1. Maximum speed is 115,200 bps for FC5A-D12*1E.
- 2. Maximum speed when data link is used.
- 3. FC5A (all types), FC4A-D20RK1, FC4A-D20RS1, FC4A-D40K3, FC4A-D40S3
- 4. FC2A-KC4C, FC2A-KM1C, FC4A-KC1C, FC4A-KC2C, FC2A-KP1C
- 5. FC2A-KP1C

HMI Module Specifications

Model	FC4A-PH1
Power Voltage	5V DC (supplied from the CPU module)
Weight	20g

Memory Cartridge Specifications

Model	FC4A-PM32	FC4A-PM64 ⁶	FC4A-PM128 ⁶
Memory Type	EEPROM		
Accessible Memory Capacity	32 KB	64 KB	128 KB
Hardware for Storing Data	CPU Module		
Software for Storing Data	WindLDR		
Quantity of Stored Programs	One user program can be stored on one memory cartridge		

- 6. Even when using a large-capacity memory cartridge, the program capacity of the CPU module takes effect, except when using FC4A-D20RK1, FC4A-D20RS1, FC4A-D40K3, and FC4A-D40S3 CPU modules, the program capacity expands to 64KB.

Clock Cartridge Specifications

Model	FC4A-PT1
Accuracy	±30 sec/month (typical) at 25°C
Backup Duration	Approx. 30 days (typical) at 25°C after backup battery fully charged
Battery	Lithium secondary battery
Charging Time	Approx. 10 hours for charging from 0% to 90% of full charge
Replaceability	Not possible to replace battery

OT Touchscreens

PLCs

Automation Software

Power Supplies

Sensors

Communication

Barriers

01 Touchscreens

PLCs

Automation Software

Power Supplies

Sensors

Communication

Barriers

Expansion Serial Communication Module
General Specifications
(Expansion RS232C Communication Module)

Model	FC5A-SIF2
No. of Port	1
Synchronization	Synchronization Start-stop synchronization
Electrical Characteristics	Electrical Characteristics EIA RS232C compliant
Maximum Delay in One Scan	Approx. 4 ms
Operating Temperature	0 to 55°C
Relative Humidity	10 to 95% (no condensation)
Recommended Cable Specifications	Shielded multi-core cable: 24AWG x 6 Dielectric strength: 2,000V AC/min Insulation resistance: 100 MΩ/km
Recommended Cable	KIDU-SB 24 AWG×6C (Nihon Electric Wire & Cable)
Connector on Mother Board	MC1.5/10-G-3.81BK (Phoenix Contact) Applicable terminal block: FC4A-PMT10P
Connector Insertion/Removal Durability	100 times minimum
Isolation from Internal Circuit	Transformer isolated
Quantity of Applicable Expansion RS232C Communication Modules	All-in-One 24-I/O type CPU module: 3 maximum ¹ Slim type CPU module: 5 maximum
Internal Current Draw	40 mA (5V/24V DC) ⁵
Weight	100g

-  Note: FC5A-SIF2 cannot be connected to FC4A CPU modules.
1. FC5A All-in-One 24-I/O CPU module cannot use the FC5A-SIF2/SIF4 module in combination with the function modules listed in the table on the left. When using these modules in combination with the FC5A-SIF2/SIF4 module, use the slim type CPU module.

Function Modules	Type No.
Analog Modules	FC4A-L03A1, FC4A-L03AP1, FC4A-J2A1, FC4A-K1A1, FC4A-J4CN1, FC4A-J8C1, FC4A-J8AT1, FC4A-K2C1, FC4A-K4A1
AS-Interface Master Module	FC4A-AS62M

5. 85 mA (5V DC), 0 mA (24V DC) when the communication module version is lower than V200.

(Expansion RS485 Communication Module)

Model	FC5A-SIF4
No. of Port	1
Synchronization	Synchronization Start-stop synchronization
Electrical Characteristics	Electrical Characteristics EIA RS485 compliant
Maximum Baud Rate	115,200 bps
Operating Temperature	0 to 55°C
Relative Humidity	10 to 95% (no condensation)
Recommended Cable Specifications	Shielded twisted pair cable: 22 AWG (0.3 mm ² x 2P) Conductor Resistance: 67 MΩ/km maximum (at 20°C)
Connector on Mother Board	MC1.5/10-G-3.81BK (Phoenix Contact) Applicable terminal block: FC4A-PMT10P
Connector Insertion/Removal Durability	100 times minimum
Isolation from Internal Circuit	Transformer isolated
Quantity of Applicable Expansion RS485C Communication Modules	All-in-One 24-I/O type CPU module: 3 maximum ¹ Slim type CPU module: 5 maximum
Internal Current Draw	40 mA (5V/24V DC)
Weight	100g

Note: FC5A-SIF4 cannot be connected to FC4A CPU modules.

Communication Specifications

Model	FC5A-SIF2	FC5A-SIF4
Maximum Baud Rate	1,200/2,400/4,800/9,600/19,200/38,400/57,600 ⁴ /115,200 ⁴	
Maintenance Communication	Possible ²	
Modbus Communication	Modbus ASCII master Modbus ASCII slave Modbus RTU master Modbus RTU slave	
Data Link	-	0 ³
Max Cable Length	10m	1,200m
Quantity of Slave Stations	1	31

-  2. Run-time program download is not possible.
 3. Data Link can be used only on one of the communication ports.
 4. Can be used when the communication module is version V200 or higher.

Specifications (I/O Modules)

Input Module Specifications

Model	FC4A-N08B1	FC4A-N16B1	FC4A-N16B3	FC4A-N32B3	FC4A-N08A11	
Input Points	8 (8/1 common)	16 (16/1 common)		32 (16/1 common)	8 (4/1 common)	
Rated Input Voltage	24V DC sink/source input signal				100 to 120V AC (50/60 Hz)	
Input Voltage Range	20.4 to 28.8V DC				85 to 132V AC	
Rated Input Current	7 mA/point (24V DC)		5 mA/point (24V DC)		17 mA/point (120V AC, 60 Hz)	
Input Impedance	3.4 kΩ		4.4 kΩ		0.8 kΩ (60 Hz)	
ON Voltage	15V minimum				79V minimum	
OFF Voltage	5V maximum				20V maximum	
ON Current	4.2 mA minimum (at 15V DC)		3.2 mA minimum (at 15V DC)		—	
OFF Current	1.2 mA maximum		0.9 mA maximum		—	
Turn ON Time	4 ms				25 ms	
Turn OFF Time	4 ms				30 ms	
Isolation	Between input terminals: Not isolated Internal circuit: Photocoupler isolated				Between input terminals in the same common: Not isolated Between input terminals in different commons: Isolated Between input terminals and internal circuits: Photocoupler isolated	
External Load for I/O Interconnection	Not needed				Not needed	
Single Determination Method	Static				Static	
Effect of Improper Input Connection	Both sink and source input signals can be connected. If any input exceeding the rated value is applied, permanent damage may be caused.				If any input exceeding the rated value is applied, permanent damage may be caused.	
Cable Length	3m in compliance with electromagnetic immunity				—	
Connector on Mother Board	MC1.5/10-G-3.81BK (Phoenix Contact)		FL20A2MA (Oki Electric Cable)		MC1.5/11-G-3.81BK (Phoenix Contact)	
Connector Insertion/Removal Durability	100 times minimum					
Applicable Ferrule	1-wire: AI 0.5-8 WH (Phoenix Contact) 2-wire: AI-TWIN 2×0.5-8 WH (Phoenix Contact)		—		—	
Internal Current Draw	All Inputs ON	25 mA (5V DC)	40 mA (5V DC)	35 mA (5V DC)	65 mA (5V DC)	60 mA (5V DC), 0 mA (24V DC)
	All Inputs OFF	5 mA (5V DC)	5 mA (5V DC)	5 mA (5V DC)	10 mA (5V DC)	30 mA (5V DC), 0 mA (24V DC)
Internal Power Consumption (at 24V DC while all inputs ON)	0.17W	0.27W	0.24W	0.44W	—	
Weight	85g	100g	65g	100g	80g	

I/O Touchscreens

PLCs

Automation Software

Power Supplies

Sensors

Communication

Barriers

Transistor Output Module Specifications

Model	FC4A-T08K1 FC4A-T08S1	FC4A-T16K3 FC4A-T16S3	FC4A-T32K3 FC4A-T32S3	
Output Points	8 (8/1 common)	16 (16/1 common)	32 (16/1 common)	
Output Type	FC4A-T□K□: Transistor sink output FC4A-T□S□: Transistor source output			
Rated Load Voltage	24V DC			
Operating Load Voltage Range	20.4 to 28.8V DC			
Maximum Load Current	0.3A per point 3A per common	0.1A per point 1A per common		
Voltage Drop (ON Voltage)	1V maximum (voltage between COM and output terminals when output is on)			
Inrush Current	1A maximum			
Clamping Voltage	39V±1V			
Maximum Lamp Load	8W			
Inductive Load	L/R = 10 ms (28.8V DC, 1 Hz)			
External Current Draw	FC4A-T□K□: 100 mA maximum, 24V DC (power voltage at the +V terminal) FC4A-T□S□: 100 mA maximum, 24V DC (power voltage at the -V terminal)			
Isolation	Between output terminal and internal circuit: Photocoupler isolated Between output terminals: Not isolated			
Connector on Mother Board	MC1.5/10-G-3.81BK (Phoenix Contact)	FL20A2MA (Oki Electric Cable)		
Connector Insertion/Removal Durability	100 times minimum			
Applicable Ferrule	1-wire: AI 0.5-8 WH (Phoenix Contact) 2-wire: AI-TWIN 2×0.5-8 WH (Phoenix Contact)			
Internal Current Draw	All outputs ON	10 mA (5V DC) 20 mA (24V DC)	10 mA (5V DC) 40 mA (24V DC)	20 mA (5V DC) 70 mA (24V DC)
	All outputs OFF	5 mA (5V DC) 0 mA (24V DC)	5 mA (5V DC) 0 mA (24V DC)	10 mA (5V DC) 0 mA (24V DC)
Internal Power Consumption (at 24V DC while all outputs ON)	0.55W	1.03W	1.82W	
Output Delay	Turn ON Time	300 μs maximum		
	Turn OFF Time	300 μs maximum		
Weight	85g	70g	105g	

Relay Output Module Specifications

Model	FC4A-R081	FC4A-R161	
Output Points	8 (4/1 common)	16 (8/1 common)	
Output Type	1NO		
Maximum Load Current	2A per point		
	7A per common	8A per common	
Minimum Switching Load	1 mA/ 5V DC (reference value)		
Initial Contact Resistance	30 mΩ maximum		
Electrical Life	100,000 operations minimum (rated load 1,800 operations/hour)		
Mechanical Life	20,000,000 operations minimum (no load 18,000 operations/hour)		
Rated Load	240V AC/2A (resistive load, inductive load cos φ = 0.4) 30V DC/2A (resistive load, inductive load L/R = 7 ms)		
Dielectric Strength	Between output and ⊕ or ⊖ terminals: 1,500V AC, 1 minute Between output terminal and internal circuit: 1,500V AC, 1 minute Between output terminals (COMs): 1,500V AC, 1 minute		
Connector On Mother Board	MC1.5/11-G-3.81BK (Phoenix Contact)	MC1.5/10-G-3.81BK (Phoenix Contact)	
Connector Insertion/Removal Durability	100 times minimum		
Applicable Ferrule	1-wire: AI 0.5-8 WH (Phoenix Contact) 2-wire: AI-TWIN 2×0.5-8 WH (Phoenix Contact)		
Internal Current Draw	All outputs ON	30 mA (5V DC) 40 mA (24V DC)	45 mA (5V DC) 75 mA (24V DC)
	All outputs OFF	5 mA (5V DC) 0 mA (24V DC)	5 mA (5V DC) 0 mA (24V DC)
Internal Power Consumption (at 24V DC while all outputs ON)	1.16W	2.10W	
Weight	110g	145g	

01 Touchscreens

PLCs

Automation Software

Power Supplies

Sensors

Communication

Barriers

Mixed I/O Module Specifications

Model		FC4A-M08BR1	FC4A-M24BR2	
Input Specifications	Input Points	4 (4/1 common)	16 (16/1 common)	
	Rated Input Voltage	24V DC sink/source input signal		
	Input Voltage Range	20.4 to 28.8V DC		
	Rated Input Current	7 mA/point (24V DC)		
	Input Impedance	3.4 kΩ		
	ON Voltage	15V minimum		
	OFF Voltage	5V maximum		
	ON Current	4.2 mA minimum (at 15V DC)		
	OFF Current	1.2 mA maximum		
	Turn ON Time	4 ms (24V DC)		
	Turn OFF Time	4 ms (24V DC)		
	Isolation	Between input terminals: Not isolated Internal circuit: Photocoupler isolated		
	External Load for I/O Interconnection	Not needed		
	Signal Determination Method	Static		
	Effect of Improper Input Connection	Both sinking and sourcing input signals can be connected. If any input exceeding the rated value is applied, permanent damage may be caused.		
Cable Length	3m in compliance with electromagnetic immunity			
Output Specifications	Output Points	4 (4/1 common)	8 (4/1 common)	
	Output Type	1NO		
	Maximum Load Current	2A per point 7A per common		
	Minimum Switching Load	1 mA/ 5V DC (reference value)		
	Initial Contact Resistance	30 mΩ maximum		
	Electrical Life	100,000 operations minimum (rated load 1,800 operations/hour)		
	Mechanical Life	20,000,000 operations minimum (no load 18,000 operations/hour)		
	Rated Load	240V AC/2A (resistive load, inductive load cos φ = 0.4) 30V DC/2A (resistive load, inductive load L/R = 7 ms)		
	Dielectric Strength	Between output and ⊕ or ⊖ terminals:	1,500V AC, 1 minute	
		Between output terminal and internal circuit:	1,500V AC, 1 minute	
Between output terminals (COMs):		1,500V AC, 1 minute		
Connector on Mother Board	MC1.5/11-G-3.81BK (Phoenix Contact)	Input: F6018-17P (Fujicon) Output: F6018-11P (Fujicon)		
Connector Insertion/Removal Durability	100 times minimum	Not removable		
Applicable Ferrule	1-wire: AI 0.5-8 WH (Phoenix Contact), 2-wire: AI-TWIN 2×0.5-8 WH (Phoenix Contact)			
Internal Current Draw	All I/Os ON	25 mA (5V DC), 20 mA (24V DC)	65 mA (5V DC), 45 mA (24V DC)	
	All I/Os OFF	5 mA (5V DC), 0 mA (24V DC)	10 mA (5V DC), 0 mA (24V DC)	
Internal Power Consumption (at 24V DC while all I/Os are ON)	0.65W	1.52W		
Weight	95g	140g		

I/O Touchscreens

PLCs

Automation Software

Power Supplies

Sensors

Communication

Barriers

Input Usage Limits

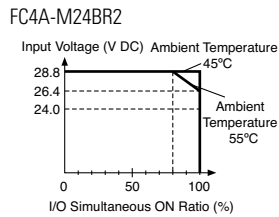
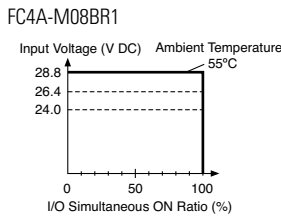
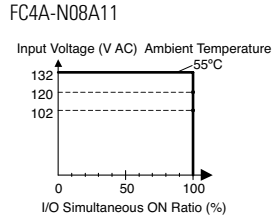
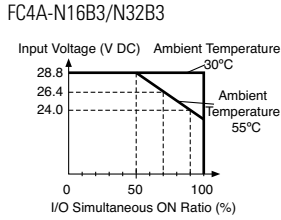
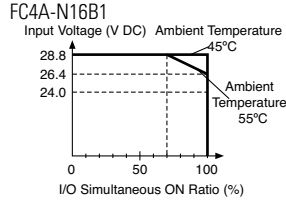
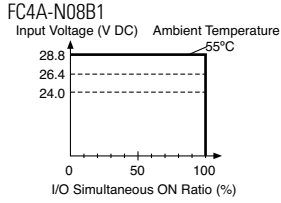

When using at an operating ambient temperature above 40°C, reduce the input voltage or the quantity of I/O points that turn on simultaneously.

Input Internal Circuit

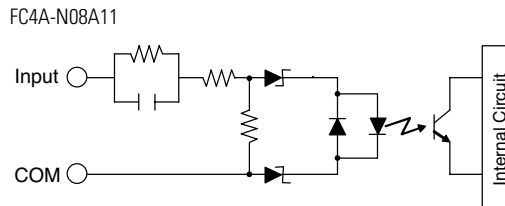
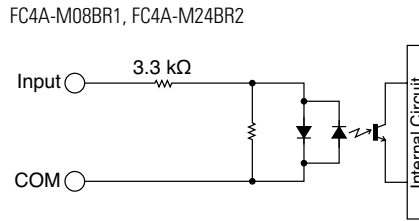
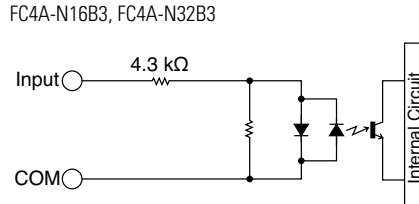
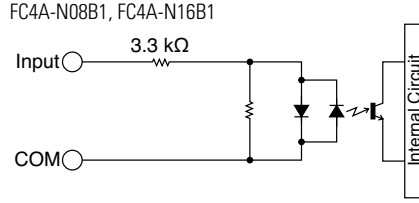

Output Internal Circuit

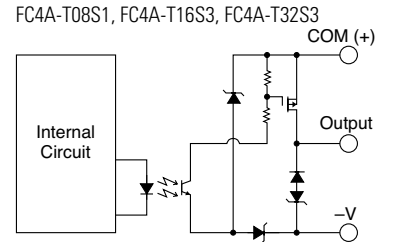
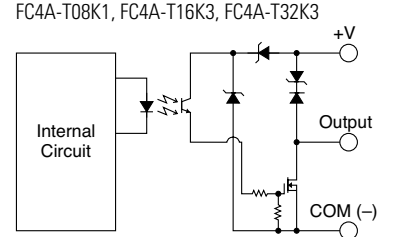

Specifications (Analog I/O Modules)

Analog I/O Module Specifications

Model	FC4A-L03A1	FC4A-L03AP1	FC4A-J2A1	FC4A-J4CN1	FC4A-J8C1	FC4A-J8AT1	FC4A-K4A1	FC4A-K1A1	FC4A-K2C1
Input Points	2	2	2	4	8	8	—	—	—
Output Points	1	1	—	—	—	—	4	1	2
Power Voltage	24V DC								
Allowable Voltage Range	20.4 to 28.8V DC								
External Current Draw * (24V DC)	45 mA	40 mA	35 mA	55 mA	50 mA	55 mA	130 mA	40 mA	85 mA
Connector on Mother Board	MC1.5/11-G-3.81BK (Phoenix Contact)			MC1.5/10-G-3.81BK (Phoenix Contact)			MC1.5/11-G-3.81BK (Phoenix Contact)		MC1.5/10-G-3.81BK (Phoenix Contact)
Connector Insertion/Removal Durability	100 times minimum								
Applicable Ferrule	1-wire: AI 0.5-8 WH (Phoenix Contact), 2-wire: AI-TWIN 2x0.5-8 WH (Phoenix Contact)								
Internal Power Consumption (5V DC)	50 mA	50 mA	50 mA	50 mA	40 mA	45 mA	65 mA	50 mA	60 mA
Internal Power Consumption (at 24V DC while all I/Os are ON)	0.34W	0.34W	0.34W	0.34W	0.27W	0.30W	0.44W	0.34W	0.40W
Weight	85g	85g	85g	140g	140g	125g	100g	85g	110g



* The external current draw is the value when all the analog inputs are used and the analog output value is at 100%.

Input Circuit

FC4A-L03A1, FC4A-L03AP1
FC4A-J2A1

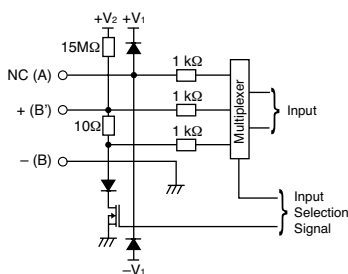

FC4A-J4CN1

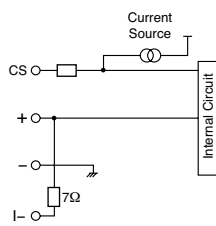

FC4A-J8C1

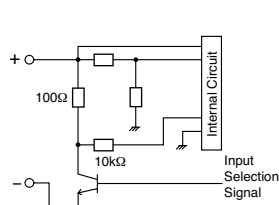

FC4A-J8AT1

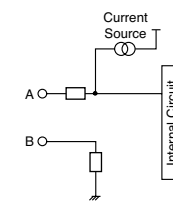

Analog Input Specifications (1)

Model		FC4A-L03A1, FC4A-J2A1		FC4A-L03AP1	
Input Signal Type		Voltage Input 0 to 10V DC	Current Input 4 to 20 mA	Resistance Thermometer Pt100 3-wire type (-100 to 500°C)	Thermocouple Type K (0 to 1,300°C) Type J (0 to 1,200°C) Type T (0 to 400°C)
Input Impedance		1 MΩ minimum	10Ω	1 MΩ minimum	1 MΩ minimum
Input Detection Current		—	—	1.0 mA maximum	—
AD Conversion	Sampling Duration Time	10 ms maximum		20 ms maximum	10 ms maximum
	Sampling Repetition Time	20 ms maximum		40 ms maximum	20 ms maximum
	Total Input System Transfer Time	60 ms + 1 scan time		80 ms + 1 scan time	60 ms + 1 scan time
	Type of Input	Single-ended input	Differential input		
	Operating Mode	Self-scan			
	Conversion Method	Σ Δ type ADC			
Input Error	Maximum Error at 25°C	±0.2% of full scale			±0.2% of full scale plus cold junction compensation error (±4°C maximum)
	Temperature Coefficient	±0.006% of full scale /°C			
	Repeatability after Stabilization Time	±0.5% of full scale			
	Non-linearity	±0.2% of full scale			
	Maximum Error	±1% of full scale			
Data	Digital Resolution	4096 increments (12 bits)		6,000 increments (14 bits)	Type K: 13,000 increments (14 bits) Type J: 12,000 increments (14 bits) Type T: 4,000 increments (14 bits)
	Input Value of LSB	2.5 mV	4 μA	0.1°C	Type K: 0.1°C Type J: 0.1°C Type T: 0.1°C
	Data Type in Application Program	Default: 0 to 4,095 Optional: -32,768 to 32,767 (selectable for each channel) ¹			
	Monotonicity	Yes			
	Input Data Out of Range	Detectable ²			
Noise Resistance	Maximum Temporary Deviation during Electrical Noise Tests	±3% maximum when a 500V clamp voltage is applied to the power supply and I/O lines ³			
	Input Filter	No			
	Recommended Cable for Noise Immunity	Twisted pair shielded cable		—	
	Crosstalk	2 LSB maximum			
Isolation	Between input and power circuit: Isolated Between input and internal circuit: Photocoupler-isolated				
Effect of Improper Input Connection	No damage				
Maximum Permanent Allowed Overload (No Damage)	13V DC	40 mA	—		
Selection of Analog Input Signal Type	Using programming software				
Calibration or Verification to Maintain Rated Accuracy	Impossible				

 1: The data processed in the analog I/O module can be linear-converted to a value between -32,768 and 32,767. The optional range designation, and analog I/O data minimum and maximum values can be selected using data registers allocated to analog I/O modules.
 2: When an error is detected, a corresponding error code is stored to a data register allocated to analog I/O operating status.
 3: The accuracy of the thermocouple input is not guaranteed when noise is applied.

OI Touchscreens

PLCs

Automation Software

Power Supplies

Sensors

Communication

Barriers

Analog Input Specifications (2)

Model	FC4A-J4CN1, FC4A-J8C1		FC4A-J4CN1	FC4A-J8AT1		
Input Signal Type	Voltage Input	Current Input	Thermocouple	Resistance Thermometer	NTC Thermistor PTC Thermistor	
Input Range	0 to 10V DC	4 to 20 mA	Type K (0 to 1,300°C) Type J (0 to 1,200°C) Type T (0 to 400°C)	Pt100, Pt1000 3-wire type (-100 to 500°C) Ni100, Ni1000 3-wire type (-60 to 180°C)	-50 to 150°C	
Input Impedance	1 MΩ	7 Ω (FC4A-J4CN1) 100Ω (FC4A-J8C1)	1 MΩ	—	—	
Input Detection Current	—	—	—	0.1 mA	0.1 mA	
AD Conversion	Sampling Duration Time	2 ms maximum				
	Sampling Repetition Time	FC4A-J4CN1: 10 ms maximum		30 ms maximum	10 ms maximum	
		FC4A-J8C1: 2 ms maximum		2 ms × channels		
	Total Input System Transfer Time	FC4A-J4CN1: 50 ms × channels + 1 scan time FC4A-J8C1: 8 ms × channels + 1 scan time		85 ms × channels + 1 scan time	50 ms × channels + 1 scan time	10 ms × channels + 1 scan time
	Type of Input	Single-ended input				
	Operating Mode	Self-scan				
	Conversion Method	Σ Δ type ADC (FC4A-J4CN1), Successive approximation register method (FC4A-J8C1, FC4A-J8AT1)				
Input Error	Maximum Error at 25°C	±0.2% of full scale		±0.2% of full scale + cold junction compensation error (±3°C maximum)	Pt100, Ni100: ±0.4% of full scale Pt1000, Ni1000: ±0.2% of full scale	±0.2% of full scale
	Cold Junction Compensation Error	—	—	±3°C maximum	—	—
	Temperature Coefficient	±0.005% of full scale/°C				
	Repeatability after Stabilization Time	±0.5% of full scale				
	Non-linearity	±0.04% of full scale			Non-linear	
	Maximum Error	±1% of full scale				
Data	Digital Resolution	50,000 increments (16 bits)		Type K: Approx. 24,000 increments (15 bits) Type J: Approx. 33,000 increments (15 bits) Type T: Approx. 10,000 increments (14 bits)	Pt100: Approx. 6,400 increments (13 bits) Pt1000: Approx. 64,000 increments (16 bits) Ni100: Approx. 4,700 increments (13 bits) Ni1000: Approx. 47,000 increments (16 bits)	Approx. 4,000 increments (12 bits)
	Input Value of LSB	0.2 mV	0.32 μA	Type K: 0.058°C Type J: 0.038°C Type T: 0.042°C	Pt100: 0.086°C Pt1000: 0.0086°C Ni100: 0.037°C Ni1000: 0.0037°C	0.05°C
Data Type in Application Program	Default: 0 to 50,000 Optional: -32,768 to 32,767 (selectable for each channel) ¹				Default: 0 to 4,000 Optional: -32,768 to 32,767 (selectable for each channel) ¹ Resistance: 0 to 10,000 Temperature: °C, °F	
Monotonicity	Yes					
Input Data Out of Range	Detectable ²					

 1: The data processed in the analog I/O module can be linear-converted to a value between -32,768 and 32,767. The optional range designation, and analog I/O data minimum and maximum values can be selected using data registers allocated to analog I/O modules.

Analog Input Specifications (2) con't on next page.

I/O Touchscreens

PLCs

Automation Software

Power Supplies

Sensors

Communication

Barriers

Analog Input Specifications (2), con't

Model	FC4A-J4CN1, FC4A-J8C1		FC4A-J4CN1		FC4A-J8AT1
Noise Resistance	Maximum Temporary Deviation during Electrical Noise Tests	±3% maximum (when a 500V clamp voltage is applied to the power supply and I/O lines)		Not assured	±3% maximum (when a 500V clamp voltage is applied to the power supply and I/O lines)
	Input Filter	Software			
	Recommended Cable for Noise Immunity	Twisted pair cable	—		
	Crosstalk	2 LSB maximum			
Isolation	Between input and power circuit: Isolated		Between input and internal circuit: Optocoupler-isolated		
Effect of Improper Input Connection	No damage				
Maximum Permanent Allowed Overload (No Damage)	11V DC	22 mA DC	—		
Selection of Analog Input Signal Type	Using programming software				
Calibration or Verification to Maintain Rated Accuracy	Impossible				

Analog Output Specifications

Model	FC4A-K4A1		FC4A-L03A1	FC4A-L03AP1	FC4A-K1A1	FC4A-K2C1	
Output Range	Voltage	0 to 10V DC				−10 to 10V DC	
	Current	4 to 20 mA					
Load	Impedance	Voltage output: 1 kΩ minimum Current output: 300Ω maximum					
	Load Type	Resistive load					
DA Conversion	Settling Time	2 ms/ch	10 ms	10 ms	10 ms	1 ms/ch	
	Total Output System Transfer Time	2 ms/ch + 1 scan time	10 ms + 1 scan time	10 ms + 1 scan time	10 ms + 1 scan time	1 ms × channels + 1 scan time	
Output Error	Maximum Error at 25°C	±0.2% of full scale					
	Temperature Coefficient	±0.015% of full scale/°C				±0.005% of full scale/°C	
	Repeatability after Stabilization Time	±0.5% of full scale					
	Output Voltage Drop	±1% of full scale					
	Non-linearity	±0.2% of full scale					
	Output Ripple	20 mV maximum				±0.1% of full scale	
	Overshoot	0%					
Data	Digital Resolution	4096 increments (12 bits)				50,000 increments (16 bits)	
	Output Value of LSB	Voltage	2.5 mV				0.4 mV
		Current	4 μA				0.32 μA
	Data Type in Application Program	Default: 0 to 4,095 (voltage, current)				−25,000 to 25,000 (voltage) 0 to 50,000 (current)	
		Optional: −32,768 to 32,767 (selected for each channel) ¹					
	Monotonicity	Yes					
Current Loop Open	Undetectable						

 1: The data processed in the analog I/O module can be linear-converted to a value between −32,768 and 32,767. The optional range designation, and analog I/O data minimum and maximum values can be selected using data registers allocated to analog I/O modules.

Analog Input Specifications con't on next page.

Analog Output Specifications, con't

Model		FC4A-K4A1	FC4A-L03A1	FC4A-L03AP1	FC4A-K1A1	FC4A-K2C1
Noise Resistance	Maximum Temporary Deviation during Electrical Noise Tests	±3% maximum when a 500V clamp voltage is applied to the power and I/O lines				
	Recommended Cable for Noise Immunity	Twisted pair shielded cable				Twisted pair cable
	Crosstalk	2LSB maximum	None			2 LSB maximum
Isolation	Between output and power circuit	Isolated				
	Between output and internal circuit	Photocoupler-isolated				
Effect of Improper Output Connection		No damage				
Selection of Analog Output Signal Type		Using software programming				
Calibration or Verification to Maintain Rated Accuracy		Impossible				

I/O Touchscreens

PLCs

Automation Software

Power Supplies

Sensors

Communication

Barriers

PID Module Specifications

Model	FC5A-F2MR2	FC5A-F2M2
Control Mode	Independent PID Control	Possible
	Heating/Cooling Control	Possible (overlapping deadband settings available) *
	Difference Input Temperature Control	Possible *
	Cascade Control	Possible *
Input Points	2ch	2ch
Types of Inputs	Thermocouple	K, J, R, S, B, E, T, N, PL-II, C (W/Re5-26) External resistance: 100Ω maximum However, external resistance of B input: 40Ω maximum
	Resistance Thermometer	Pt100, JPt100, 3-wire type Allowable conductor resistance (per wire): 10Ω maximum
	Current Input	0 to 20 mA DC, 4 to 20 mA DC Input impedance: 50Ω Maximum permanent allowed overload (no damage): 50 mA maximum
	Voltage Input	0 to 1V DC Input impedance: 1MΩ minimum Maximum permanent allowed overload (No damage): 5V DC Allowable output impedance: 2 kΩ 0 to 5V DC, 1 to 5V DC, 0 to 10V DC Input impedance: 100kΩ minimum Maximum permanent allowed overload (No damage): 15V DC maximum Allowable output impedance: 100Ω maximum
AD Conversion	Sampling Duration Time	100 ms
	Sampling Repetition Time	125 ms
	Type of Input	Differential input
	Conversion Method	Σ Δ type ADC
Maximum Error at 25°C	Thermocouple Input	±0.2% of full scale or ±2°C (4°F), whichever is greater However, R, S inputs: 0 to 200°C (0 to 400°F): ±6°C (12°F) B input: 0 to 300°C (0 to 600°F) Accuracy is not guaranteed. K, J, E, T, N inputs: Less than 0°C (32°F): ±0.4% of full scale
	Resistance Thermometer Input	±0.1% of full scale or ±1°C (2°F), whichever is greater
	Voltage/Current Inputs	±0.2% of full scale
Input Accuracy (at 0 to 55°C)	Thermocouple Input	±0.7% of full scale However, R, S input: 0 to 200°C (0 to 400°F): ±6°C (12°F) B input: 0 to 300°C (0 to 600°F) Accuracy is not guaranteed. K, J, E, T, N inputs: Less than 0°C (32°F): ±0.9% of full scale
	Resistance Thermometer Input	±0.6% of full scale
	Voltage/Current Inputs	±0.7% of full scale
Noise Resistance	Maximum Temporary Deviation during Electrical Noise Tests	Voltage input, current input ±3% maximum when a 500V clamp voltage is applied to the power supply and I/O lines Thermocouple, Resistance Thermometer Not assured
	Input Filter	None
	Recommended Cable for Noise Immunity	Twisted pair cable
Cross Talk		None
	Isolation	Between input and power circuit: Transformer Isolated Between input and internal circuit: Optocoupler isolated
	Data Accuracy	Maximum error at 25°C±Minimum digital resolution of each input range
Cold Junction Temperature Compensation Accuracy		±1°C at 0 to 55°C
Sampling Period		125 ms
Output Points		2ch

 *Dual channel input is required for one loop circuit.

PID Module Specifications can't on next page.

PID Module Specifications, con't

Model		FC5A-F2MR2	FC5A-F2M2
Output		Relay output 1NO Rated load 5A 250V AC/30V DC (resistive load) 3A 250V AC (inductive load cos φ=0.4) Minimum open/closed load: 10 mA 5V DC Electrical life: 100,000 cycles (at the maximum rating of resistive load)	Non-contact voltage output (for SSR drive) 12V DC±15% Maximum 40 mA (short circuit protected) Leakage current: 0.3 mA maximum Analog current output 4 to 20 mA DC Maximum Error: ±0.5% Full Scale at 25°C ±1.0% Full Scale at 55°C Load resistance: 550Ω maximum Analog output digital resolution: 1,000 LSB input value: 0.016 mA
Noise Resistance	Maximum Temporary Deviation during Electrical Noise Tests	—	±3% maximum when a 500V clamp voltage is applied to the power supply and I/O lines
	Recommended Cable for Noise Immunity	—	Twisted pair cable
	Cross Talk	—	None
Isolation		Between output and power circuit: Transformer Isolated	Between output and power circuit: Transformer Isolated Between output and internal circuit: Optocoupler isolated
Power Voltage		24V DC (External power), 5V DC (Internal power)	
Allowable Voltage Range		20.4 to 28.8V DC	
External Power Consumption		Approx. 3.5W maximum	
Internal Power Consumption (at 24V DC while all I/Os are on)		65mA (5V DC)	
Connector on Mother Board		Input: F6018-17P (Fujicon)	Output: F6018-11P (Fujicon)
Weight (approx.)		140g	

Input Range

Input	Input Range (Digital Resolution)		Input Value of LSB
K	-200 to 1,370°C	-328 to 2,498°F	1°C (°F)
	-200.0 to 400.0°C	-328.0 to 752.0°F	0.1°C (°F)
J	-200 to 1,000°C	-328 to 1,832°F	1°C (°F)
R	0 to 1,760°C	32 to 3,200°F	1°C (°F)
S	0 to 1,760°C	32 to 3,200°F	1°C (°F)
B	0 to 1,820°C	32 to 3,308°F	1°C (°F)
E	-200 to 800°C	-328 to 1,472°F	1°C (°F)
T	-200.0 to 400.0°C	-328.0 to 752.0°F	0.1°C (°F)
N	-200 to 1,300°C	-328 to 2,372°F	1°C (°F)
PL-II	0 to 1,390°C	32 to 2,534°F	1°C (°F)
C (W/Re5-26)	0 to 2,315°C	32 to 4,199°F	1°C (°F)
Pt100	-200.0 to 850.0°C	-328.0 to 1,562.0°F	0.1°C (°F)
	-200 to 850°C	-328 to 1,562°F	1°C (°F)
JPt100	-200.0 to 500.0°C	-328.0 to 932.0°F	0.1°C (°F)
	-200 to 500°C	-328 to 932°F	1°C (°F)
4 to 20mA DC	-2,000 to 10,000 (12,000 increments)		1.333 μA
0 to 20mA DC	-2,000 to 10,000 (12,000 increments)		1.666 μA
0 to 1V DC	-2,000 to 10,000 (12,000 increments)		0.083 mA
0 to 5V DC	-2,000 to 10,000 (12,000 increments)		0.416 mA
1 to 5V DC	-2,000 to 10,000 (12,000 increments)		0.333 mA
0 to 10V DC	-2,000 to 10,000 (12,000 increments)		0.833 mA

I/O Touchscreens

PLCs

Automation Software

Power Supplies

Sensors

Communication

Barriers

Expansion Interface Module Specifications

01 Touchscreens

PLCs

Automation Software

Power Supplies

Sensors

Communication

Barriers

Type No.	FC5A-EXM1M (Expansion Interface Master Module)	FC5A-EXM1S (Expansion Interface Slave Module)	FC5A-EXM2 (Expansion Interface Module)
Rated Power Voltage	—	24V DC (supplied from external power)	24V DC (supplied from external power)
Allowable Voltage Range	—	20.4 to 26.4V DC (including ripple)	20.4 to 26.4V DC (including ripple)
Current Draw (Internal Power/External Power)	Internal power (supplied from CPU module): 90 mA (5V DC) 0 mA (24V DC)	Internal power (supplied from CPU module): 0 mA (5V DC) 0 mA (24V DC) External power: With I/O modules 750 mA (26.4V DC) ¹	Internal power (supplied from CPU module): 50 mA (5V DC) 0 mA (24V DC) External power: With I/O modules 750 mA (26.4V DC) ¹
Maximum Power Consumption (External Power) ¹	—	19W (26.4V DC)	19W (26.4V DC)
Allowable Momentary Power Interruption	—	10 ms minimum (24V DC)	10 ms minimum (24V DC)
I/O Expansion	Between CPU module and expansion interface module Connectable CPU modules: FC5A-D16RK1/D16RS1/D32K3/D32S3/D12K1E/D12S1E Connectable I/O modules: 7 maximum Beyond the expansion interface module Connectable I/O modules: 8 digital I/O modules maximum (AC input modules are not applicable) ²		
Maximum I/O Refresh Time ³	3.6 ms		2.8 ms
Communication between CPU Module and Expansion Interface Module	Asynchronous communication (I/O refresh of I/O modules on both sides of the expansion interface module is asynchronous.)		
Isolation from Internal Circuit	Only communication interface part is isolated		Not isolated
EMC Compliant Cable Length	1m (FC5A-KX1C)		—
Power Supply Connector	Connector on Mother Board	—	MKDSN1.5/3-5.08-BK (Phoenix Contact)
	Connector Insertion/Removal Durability	—	100 times minimum
Expansion Cable Connector	Connector on Mother Board	FCN-365P024-AU (Fujitsu Component)	
	Connector Insertion/Removal Durability	100 times minimum	
Weight	70g	135g	140g



1: Power consumption by the expansion interface module and eight I/O modules.
 2: The maximum number of relay outputs that can be turned on simultaneously is 54 points.
 3: Maximum I/O refresh time of the expansion interface module. D8252 stores the refresh time.

Dimensions (mm)

FC5A-D16RK1, FC5A-D16RS1,
FC4A-D20RK1, FC4A-D20RS1

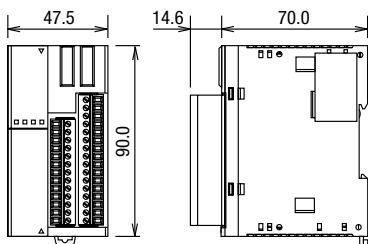

FC5A-D32K3, FC5A-D32S3, FC4A-D40K3,
FC4A-D40S3

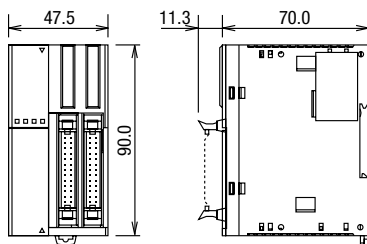

FC5A-D12K1E, FC5A-D12S1E

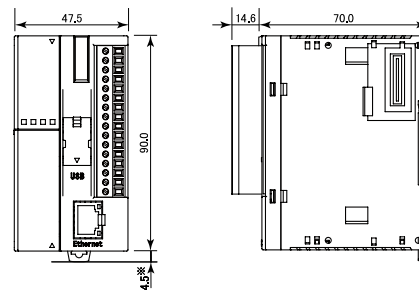

FC5A-C10R2, FC5A-C16R2,
FC5A-C10R2C, FC5A-C16R2C,
FC5A-C10R2D, FC5A-C16R2D,
FC4A-C10R2, FC4A-C16R2,
FC4A-C10R2C, FC4A-C16R2C

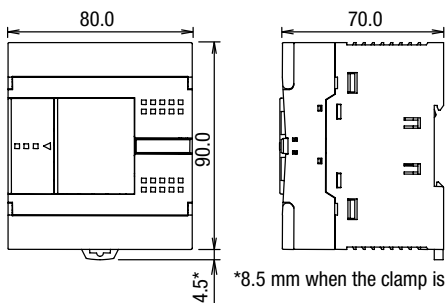

FC5A-C24R2, FC5A-C24R2C, FC5A-C24R2D,
FC4A-C24R2, FC4A-C24R2C

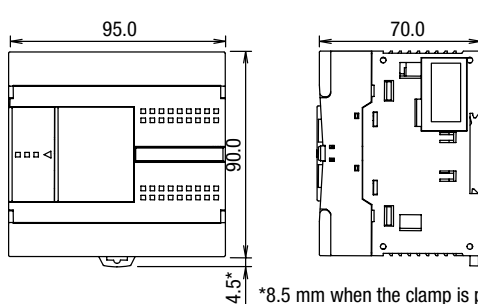

FC4A-D20K3, FC4A-D20S3

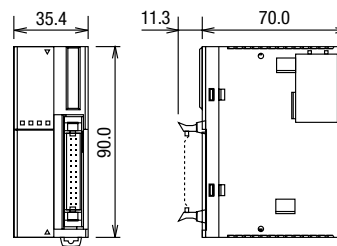

*8.5 mm when the clamp is pulled out.

*8.5 mm when the clamp is pulled out.

FC4A-N16B1, FC4A-R161, FC4A-J4CN1,
FC4A-J8C1, FC4A-J8AT1

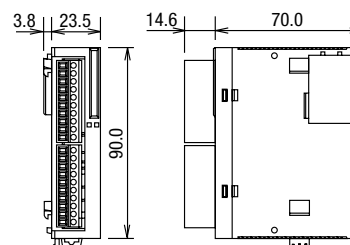

FC5A-SIF2, FC5A-SIF4,
FC4A-AS62M, FC4A-N08A11,
FC4A-J2A1, FC4A-N08B1,
FC4A-K1A1, FC4A-R081,
FC4A-K2C1, FC4A-T08K1,
FC4A-L03A1, FC4A-T08S1,
FC4A-L03AP1, FC4A-K4A1,
FC4A-M08BR1

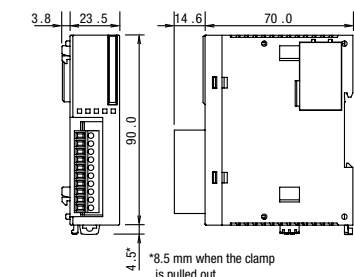

FC4A-N16B3, FC4A-T16K3, FC4A-T16S3

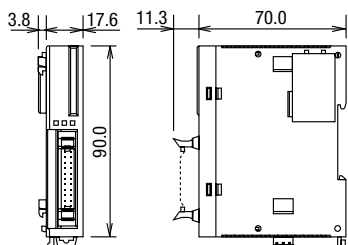

FC4A-N32B3, FC4A-T32K3, FC4A-T32S3

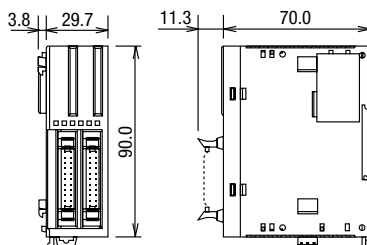

FC4A-HPC1, FC4A-HPC2, FC4A-HPC3

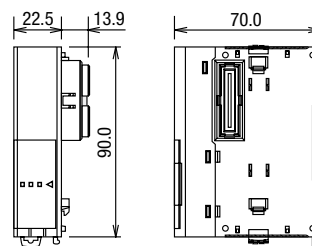

FC5A-F2MR2, FC5A-F2M2, FC4A-M24BR2

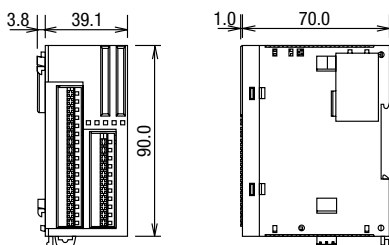

FC4A-HPH1

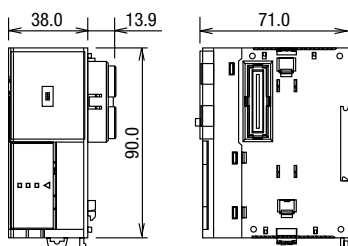

FC4A-SX5ES1E

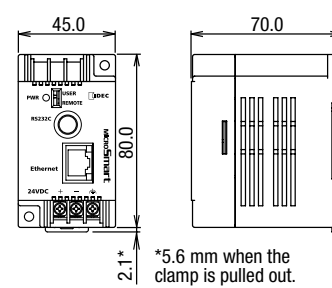

*5.6 mm when the clamp is pulled out.

OT Touchscreens

PLCs

Automation Software

Power Supplies

Sensors

Communication

Barriers

FC5A-EXM2

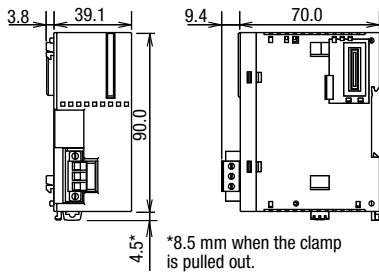

FC5A-EXM1M

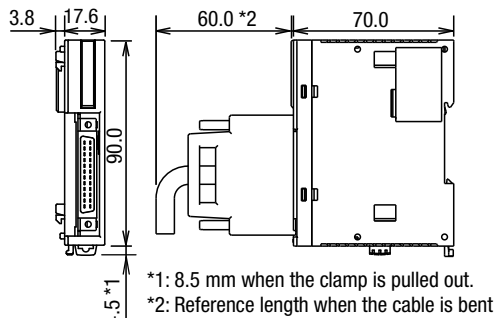

FC5A-EXM1S

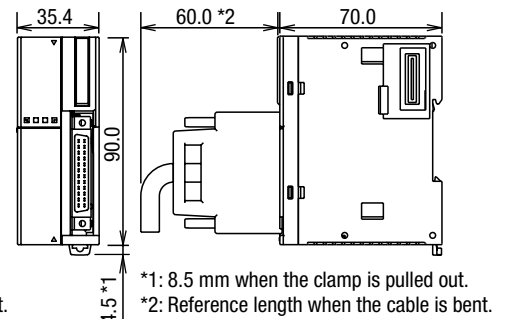

Example

The following figure illustrates a system setup consisting of the all-in-one 24-I/O type CPU module, an 8-point relay output module, and a 16-point DC input module mounted on a 35-mm-wide-DIN rail using BNL6 end clips.

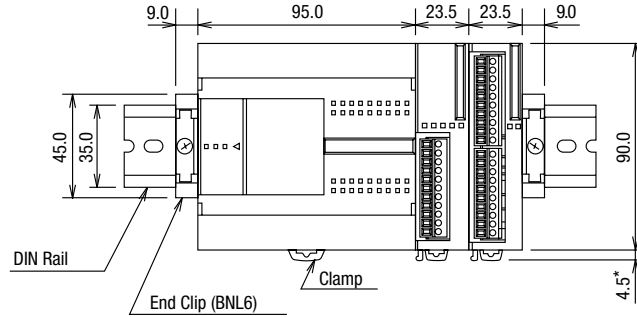

*8.5 mm when the clamp is pulled out.

Mounting Hole Layouts

- FC5A-C10R2, FC5A-C10R2C,
- FC5A-C10R2D, FC5A-C16R2,
- FC5A-C16R2C, FC5A-C16R2D
- FC4A-C10R2, FC4A-C10R2C
- FC4A-C16R2, FC4A-C16R2C

- FC5A-C24R2
- FC5A-C24R2C
- FC5A-C24R2D
- FC4A-C24R2
- FC4A-C24R2C

- FC5A-D12K1E, FC5A-D12S1E
- FC5A-D16RK1, FC5A-D16RS1
- FC5A-D32K3, FC5A-D32S3
- FC4A-D20RK1, FC4A-D20RS1
- FC4A-D40K3, FC4A-D40S3

- FC5A-SIF2, FC5A-SIF4
- FC4A-AS62M, FC4A-N08A11,
- FC4A-J2A1, FC4A-N08B1, FC4A-
- J4CN1, FC4A-N16B1, FC4A-
- J8AT1, FC4A-R081, FC4A-J8C1,
- FC4A-R161,
- FC4A-K1A1, FC4A-T08K1, FC4A-
- K2C1, FC4A-T08S1, FC4A-L03A1,
- FC4A-K4A1, FC4A-L03AP1, FC4A-
- M08BR1

FC4A-SX5ES1E

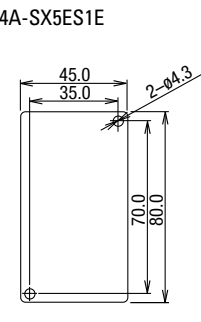
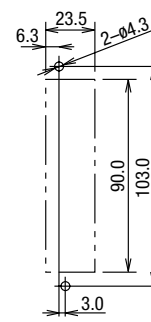
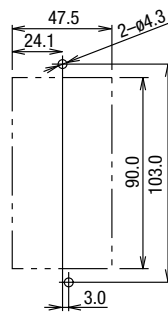
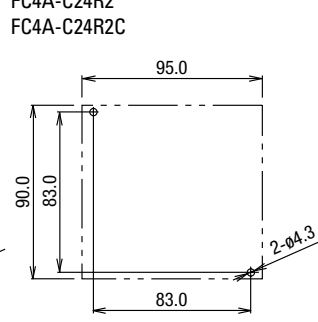
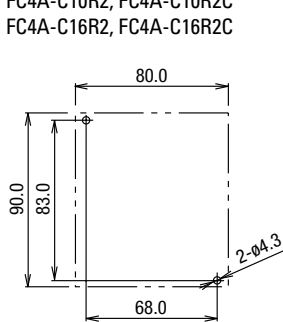

FC4A-N32B3
FC4A-T32K3
FC4A-T32S3

FC5A-F2MR2
FC5A-F2M2
FC5A-EXM2
FC4A-M24BR2

FC5A-EXM1S
FC4A-D20K3
FC4A-D20S3

FC5A-EXM1M
FC4A-N16B3
FC4A-T16K3
FC4A-T16S3

FC4A-HPC1
FC4A-HPC2
FC4A-HPC3

FC4A-HPH1

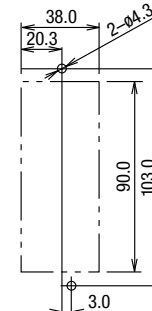
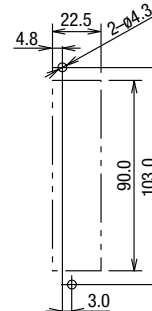
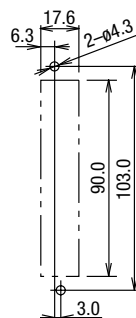
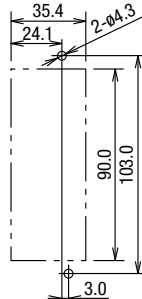
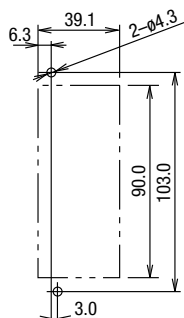
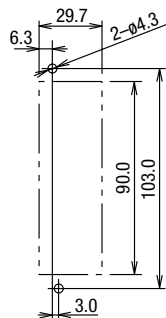

Example

Mounting hole layout for FC5A-C24R2 or FC4A-C24R2 and four 23.5mm-wide I/O modules

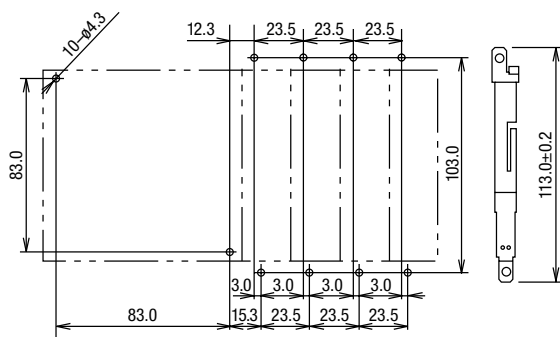

Example

Mounting hole layout from left, FC4A-HPH1, FC4A-D20K3, FC4A-N16B3, FC4A-N32B3, and FC4A-M24R2 modules

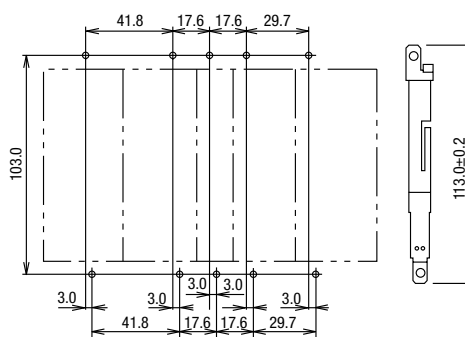

All dimensions in mm.

IDEC SmartRelay – The Intelligent Choice



Increase your versatility with a new remote display

Look around. IDEC SmartRelays are in everything from lighting controls to ice-making machines and grocery store misters. Proving reliable time after time, these intelligent logic modules are the ideal controller for simple automation tasks. A new fifth-generation of SmartRelays offer functions to give you even more flexibility and convenience. Advances include extended memory, a brighter display with higher LCD contrast, improved analog and high-speed inputs, an external text display, and upgraded programming software.

With an ever changing market and tough competition, you need an edge to stay on top. SmartRelay has a new HMI text display panel to do just that! This economical interface lets you make quick adjustments, while at the same time making it easy to spot and troubleshoot failures using built-in operator functions and diagnostics. So why wait? Make the smart choice, IDEC SmartRelay!

Industrial Facility Systems



- Conveyor systems
- Elevator controls
- Exhaust and filtering systems
- Automatic food dispensing machines
- Water treatment and irrigation systems
- Motor, pump and valve controls

Housing and Building Management



- Lighting controls (outside and inside)
- Door and gate controls
- Heating and cooling systems
- Shutter, sun blind and awning controls
- Water and sprinkler systems
- Ventilation systems

Unique Solutions



- Solar-electric systems
- Marine systems
- Extreme environmental conditions
- Display panels and traffic light controls
- Energy management

Monitoring Systems



- Access controls
- Alarm systems
- Limit level monitoring
- Parking Lot monitoring
- Baggage control

www.IDEC.com/smartrelay

OI Touchscreens

PLCs

Automation Software

Power Supplies

Sensors

Communication

Barriers

New Faster Inputs

FL1E can support up to four 5KHz high-speed inputs. You have the option of configuring inputs I3, I4, I5 and I6 as fast counter inputs to give you even more flexibility.

Universal Voltages

Available in 12/24V DC for solar and vehicle applications, and 24V AC/DC for building automation, as well as 100-240V AC/DC, SmartRelay can be used for a wide variety of applications.

DIN Rail or Surface Mountable

New Controllable Backlit LCD Display

FL1E SmartRelays have a built-in LCD display with a brighter, higher contrast screen you can adjust to your own preference. System status — input, output, analog values, timers and counters — can be monitored through the 4x12 LCD screen or you can display a predefined message with up to 48 characters (chosen from 103 special character types). Non-LCD versions are also available.

EEPROM Memory

With IDEC SmartRelays, your program is stored in a non-volatile EEPROM Memory.

New Extended Retentive Data Memory

Extended memory gives you up to 250 bytes of retentive data memory. More than 4 times that of FL1D!

New Arithmetic Functions

Analog Math function blocks allow basic arithmetic operations such as addition, subtraction, multiplication, and division.

Password Protection

Concerned about your program being copied or altered? IDEC SmartRelays keep you safe with a unique password protection scheme allowing end users to access certain parameters without seeing or modifying the actual program.

New Built-in Analog Inputs

Each SmartRelay is equipped with 8 digital inputs that can be used for your applications. New in the FL1E 12/24VDC and 24VDC models are four built-in analog inputs. Inputs I1, I2, I7, and I8 can now be configured to accept 0-10V analog signals. Using expansion modules, you can utilize a maximum of 24 digital and 8 analog inputs.



New Memory Cartridges

Three memory cartridges are now available for FL1E: Violet, Green and Brown! Violet is a 32K high-capacity, removable program memory card. Green is a battery card that supports a Real Time Clock power supply for up to two years. Brown is a combined memory/battery card.



Operational Control Buttons

Program with just the push of a button! SmartRelay control buttons can be used to program, modify and change preset parameters. The four cursor keys can also be configured as inputs as needed.

Digital Outputs

IDEC SmartRelays are equipped with four relay outputs rated at 10A/pt. Using digital expansion modules; you can configure a maximum of sixteen outputs.

New 50% More Memory

FL1E SmartRelays offer an expanded program memory of 200 function blocks! This is a 50% increase compared to the existing FL1D series.

Additional text display

For the first time ever, you can connect an external text display to your SmartRelay, making it easy for you to monitor, view and troubleshoot from outside your panel. Turn to page 7 to learn more!

Quality

IDEC has built a reputation based on providing high-quality, dependable products you can trust, and our SmartRelays are no exception. Each model is cULus listed, CE certified, EMC compliant, FM approved for Class 1 Div 2 hazardous locations, C-tick compliant, Lloyds Registered and ABS approved.

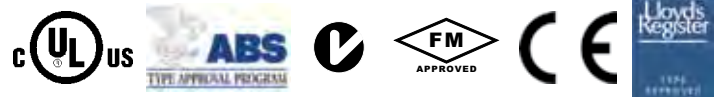

IO Touchscreens

PLCs

Automation Software

Power Supplies

Sensors

Communication

Barriers

Part Numbers

Base Modules – with LCD

Style	Part Number	Voltage	Input Signal	Input	Output	With Clock
	FL1E-H12RCE	12/24V DC	DC I1, I2, I7 and I8 are used for digital/analog	PNP	Relay	Yes
	FL1E-H12SND	24V DC			Transistor Source	
	FL1E-H12RCA	24V AC/DC	AC/DC	PNP/NPN	Relay	Yes
	FL1E-H12RCC	100-240V AC/DC				

Base Modules – without LCD

Style	Part Number	Voltage	Input Signal	Input	Output	With Clock
	FL1E-B12RCE	12/24V DC	DC I1, I2, I7 and I8 are used for digital/analog	PNP	Relay	Yes
	FL1E-B12RCA	24V AC/DC				
	FL1E-B12RCC	100-240V AC/DC	AC/DC	PNP	Relay	Yes

Text Message Display

Style	Part Number	Rated Voltage	Description
	FL1E-RD1	12 VDC, 24 VAC/DC	FL1E Text Display Panel

Digital I/O Expansion Modules

- 8-pt expansion module (4 in/4 out)
- Max. 4 digital expansion modules

Style	Part Number	Total I/O	Input Power	Input	Output
	FL1B-M08B2R2	8 (4 in/ 4 out)	12/24V DC	DC	Relay
	FL1B-M08B1S2		24V DC		Transistor Sink
	FL1B-M08C2R2		100-240V AC/DC	AC/DC	Relay
	FL1B-M08D2R2		24V AC/DC		

Analog I/O Expansion Modules

- 2-pt Analog input module
- 2-pt Analog output module
- 10-bit resolution
- Max. 4 analog input modules and 1 analog output module

Style	Part Number	Total I/O	Input Power	Input	Output
	FL1B-J2B2	2 (2 in/0 Out)	12/24V DC	0-10V, 4-20mA	—
	FL1D-K2BM2	2 (0 in/2 Out)	24V DC	—	0-10V, 4-20mA

AS-Interface Communication Module

- The AS-Interface communication module provides optimum solutions for decentralized controls and savings in installation space and wiring
- Virtual I/O points: 4 inputs, 4 outputs

Style	Part Number	Module	Input Power	Total I/O
	FL1B-CAS2	AS-Interface Communication Module	30V DC	Input: 4 points Output: 4 points

Starter Kits

IDEC SmartRelay Starter Kit is an economical and ideal solution for first time IDEC SmartRelay users

- Package includes a base module, WindLGC programming software, USB programming cable, simulator switch (DC models only) and a user's manual



Starter Kits

Part Number	Description
SMARTSTART-BAC-E	FL1E-B12RCC, WindLGC software and programming cable
SMARTSTART-BDC-E	FL1E-B12RCE, WindLGC software, programming cable, and simulator switch
SMARTSTART-HAC-E	FL1E-H12RCC, WindLGC software and programming cable
SMARTSTART-HDC-E	FL1E-H12RCE, WindLGC software, programming cable, and simulator switch

Accessories

Part Number	Description
FL9Y-LP1CDW	WindLGC 6.0 programming software
FL1E-PC2	SmartRelay USB programming cable
FL1E-PM4	FL1E SmartRelay memory cartridge
FL1E-PB1	FL1E SmartRelay battery cartridge
FL1E-PG1	FL1E SmartRelay memory and battery combination cartridge
FL9Y-B1090-0	FL1E SmartRelay user's manual
FL1B-Y1371-SW8	8-pt simulator switch, used with 12-24VDC, 24VDC base module only



WindLGC Software
FL9Y-LP1CDW

WindLGC

Programming Software

WindLGC is the exclusive programming software for the IDEC SmartRelay using Windows®. Edit, save, and print out your programs.

Key features:

- Ladder programming
- Online Monitor
- Program Comparison
- Time Simulation
- Simplified connection of the functions
- Programs can be saved in PDF or JPG format

Just click the function blocks you need and link function blocks for easy wiring. Devise complicated circuits using the convenient functions of WindLGC.

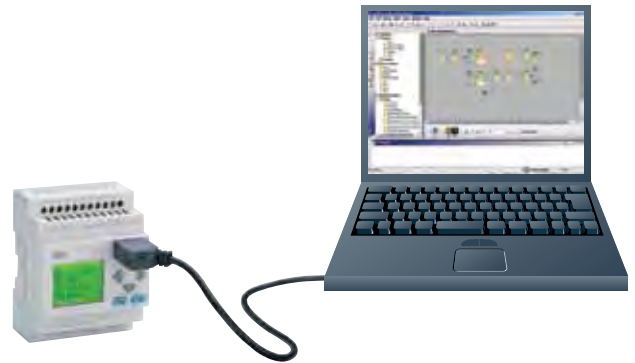
**Part Number**

Part Number	Description
FL9Y-LP1CDW	WindLGC programming software for IDEC SmartRelay

WindLGC system requirements:

- OS: Windows95/98/ME/NT/2000/XP/Vista and Windows 7
- CPU recommendation: Pentium 266MHz or higher
- Memory: 64MB or more
- RAM recommendation: 128MB
- Hard disk space: 90MB or more for installing WindLGC software.
- Monitor Recommendation: Display more than 800 x 600 dots and 256 colors
- Free download service, if upgrading from WindLGC Version 3.0 to Version 5.0, available at www.idec.com/usa

Program Comparison**Simulation Mode/Online Monitor****Ladder Programming**

For more information, see the Automation Software section.
Visit www.IDEC.com/downloads for free upgrades or a free demo version.

Specifications

Base Modules

Style	with LCD Display	FL1E-H12SND	FL1E-H12RCE	FL1E-H12RCA	FL1E-H12RCC	
	without Display	—	FL1E-B12RCE	FL1E-B12RCA	FL1E-B12RCC	
Power Supply	Rated Power Voltage	24V DC	12/24V DC	24V AC/DC	100 to 240V AC/DC	
	Allowable Voltage Range	20.4 to 28.8V DC	10.8 to 28.8V DC	20.4 to 26.4V AC, 20.4 to 28.8V DC	85 to 265V AC, 100 to 253V DC	
	Rated Frequency	—	—	47 to 63Hz	47 to 63Hz	
	Current Draw	40 to 75mA (24V DC)	60 to 175mA (12V DC) 40 to 100mA (24V DC)	76 to 182mA (24V AC) 40 to 100mA (24V DC)	25 to 40mA (100V AC), 20 to 30mA (240V AC) 10 to 25mA (100V DC), 6 to 15mA (240V DC)	
	Allowable Momentary Power Interruption	—	2ms (Typ.) (12V DC) 5ms (Typ.) (24V DC)	5ms (Typ.) (24V AC/DC)	10ms (Typ.) (100V AC/DC) 20ms (Typ.) (240V AC/DC)	
	Power Consumption	0.7 to 1.3W (24V DC)	0.3 to 1.7W (12V DC) 0.4 to 1.8W (24V DC)	0.9 to 2.7VA (24V AC) 0.4 to 1.8W (24V DC)	1.1 to 4.6VA (100V AC), 2.4 to 6.0VA (240V AC) 0.5 to 2.9W (100V DC), 1.2 to 3.6W (240V DC)	
	Reverse Polarity Protection	Yes	Yes	—	—	
Clock	Backup Duration	—	80 hours (25°C) ¹	80 hours (25°C) ¹	80 hours (25°C) ¹	
	Clock Accuracy	—	±2 sec/day maximum	±2 sec/day maximum	±2 sec/day maximum	
Input	Input Signal	DC		AC/DC	AC/DC	
	Input Points	8 (I1 to I8)		8 (I1 to I8)	8 (I1 to I8)	
	Analog Input Points	4 (I1, I2, I7, I8)		—	—	
	High-speed Input ²	4 (I3, I4, I5, I6), 5Khz maximum		—	—	
	Analog	Input Range	0 to 10V DC (max. rated input: 28.8V DC)		—	—
		Input Error	±1.5 (of full scale)		—	—
		Input Resolution	10 bits (0 to 1000)		—	—
		Allowable Voltage Range	0 to 28.8V DC		—	—
	Input Impedance	Digital Input	3.5kΩ		4.8kΩ	840kΩ
		Analog Input	72kΩ		—	—
	Isolation	—	—	—	—	
	Operating Range	OFF Voltage	< 5V DC		< 5V AC/DC	< 40V AC, < 30V DC
		ON Voltage	≥ 12V DC		≥ 12V AC/DC	≥ 79V AC, ≥ 79V DC
		OFF Current	< 0.85mA (I1 to I6), < 0.05mA (I1, I2, I7, I8)		< 1.0mA	< 0.03mA
ON Current		≥ 2mA (I3 to I6) ≥ 0.15mA (I1, I2, I7, I8)	≥ 1.5mA (I3 to I6) ≥ 0.1mA (I1, I2, I7, I8)	≥ 2.5mA	≥ 0.08mA, 100V AC: 50ms (Typ.)	
Turn ON Time	1.5ms (Typ.) ≤ 1.0ms (I3, I6)		1.5ms (Typ.)	100V AC: 50ms (Typ.), 240V AC: 30ms (Typ.) 100V DC: 25ms (Typ.) 240V DC: 15ms (Typ.)		
Turn OFF Time	1.5ms (Typ.) ≤ 1.0ms (I3, I6)		15ms (Typ.)	100V AC: 65ms (Typ.), 240V AC: 105ms (Typ.) 100V DC: 95ms (Typ.), 240V DC: 125ms (Typ.)		
Wire Length	100m ³		100m ³	100m		

- 1. Two year backup duration (typ.) when battery cartridge or memory/battery cartridge used.
- 2. When selecting frequency trigger function and up/down counter function.
- 3. 10m when connected to analog input (twisted pair cable).

Specifications can't on next page.

01 Touchscreens

PLCs

Automation Software

Power Supplies

Sensors

Communication

Barriers

Specifications con't

Style	with LCD Display	FL1E-H12SND	FL1E-H12RCE	FL1E-H12RCA	FL1E-H12RCC
	without Display	—	FL1E-B12RCE	FL1E-B12RCA	FL1E-B12RCC
Output	Output	Transistor source		Relay	
	Output Points/ Contact Configuration	4 points (separate)		4NO contacts	
	Isolation	—		Isolated	
	Dielectric Strength (between power/input terminals and output terminals)	—		2500V AC, 1 minute, 500V DC, 1 minute	
	Output Voltage	External power voltage		—	
	Maximum Load Current	0.3A		Resistive load: 10A at 12/24V AC/DC, 10A at 100/120V AC, 10A at 230/240V AC Inductive load: 2A at 12/24V AC/DC, 3A at 100/120V AC, 3A at 230/240V AC	
	Surge Current	—		30A maximum	
	Short-circuit Protection	Built-in current limiting resistor: Approx. 1A		External fuse required: 16A maximum	
	Minimum Switching Load	—	10mA, 2V DC	10mA, 12V DC	
	Initial Contact Resistance	—		100 mΩ maximum (at 1A, 24V DC)	
	Mechanical Life	—		10 million operations (no load, 10Hz)	
	Electrical Life	—		100,000 operations (rated resistive load) 1800 operations/hour	
Switching Rate	Mechanical Load	—		10Hz	
	Electrical Load	10Hz		—	
	Resistive Load/Lamp Load ¹	10Hz		2Hz	
	Inductive Load	0.5Hz		0.5Hz	

1. For fluorescent lamps, if the inrush current exceeds the allowable value, use an appropriate relay.

General

Style	Specification	Standard
Operating Temperature	Horizontal Mounting	0 to 55°C
	Vertical Mounting	0 to 55°C
Storage/Transportation Temperature	-40 to +70°C (no freezing)	—
Relative Humidity	10 to 95% RH (no condensation)	IEC60068-2-30
Atmospheric Pressure	795 to 1080 hPa	—
Operating Condition	No corrosive gas	—
Degree of Protection	IP20	—
Vibration Resistance	5 to 8.4Hz, amplitude 3.5mm 8.4 to 150Hz, acceleration 9.8m/s ²	IEC60068-2-6
Shock Resistance	147m/s ²	IEC60068-2-27
Drop Test	0.3m	IEC60068-2-31
Drop Test (packaged)	1m	IEC60068-2-32
Emission	Class B Group ¹	EN55011
Electrostatic Discharge	8kV air discharge, 6kV contact discharge ²	IEC61000-4-2
Radiation Field Immunity	Field Strength: 1V/m and 10V/m	IEC61000-4-3
Burst Pulses	2kV (power line), 1kV (I/O signal line) ³	IEC61000-4-4
Energy Carriers Single Pulse (Surge) ⁴ (FL1E-H12RCC, FL1E-B12RCC only)	1kV (power line) normal 2kV (power line) common	IEC61000-4-5
Communication Cable	0.5 to 2.5mm ² (one wire), 0.5 to 1.5mm ² (two wires)	—
Terminal Style	Finger-safe type ⁵	—

- Class A for AS-Interface communication module.
- 8kV (air discharge), 4kV (contact discharge) for AS-Interface communication module.
- 1kV (criteria A), 2kV (criteria B) for AS-Interface communication module.

- For protection against surge noise on DC power supply types (FL1E-H12RCE/B12RCE, FL1E-H12SND, FL1E-H12RCA/B12RCA), use surge absorbers, noise cut transformers, or noise filters. Use of surge protection device (DEHN + SOHNE GmbH + Co. VVT AD 24 Part No. 918 402) is recommended.
- Tightening torque 0.4 to 0.5 N-m.

Text Display

Part Number	FL1E-RD1	
Keyboard Display	Membrane keypad with 10 keys, FSTN-Graphic Display with 128 x 64 (columns x rows), LED backlight	
Power Supply	Input Voltage	24V AC/DC, 12V DC
	Allowable Voltage Range	20.4 to 26.4V AC, 10.2 to 28.8V DC
	Rated Frequency	47 to 63Hz
	Current Draw	30 to 55mA (24V DC)
Power Consumption	12V DC	65mA
	24V DC	40mA
	24V AC	90mA
Data Transmission Rate	19200 baud	
LCD Display	Backlight lifetime ¹	20,000 hours
	Display lifetime ²	50,000 hours
Weight	220g	

Connect the text display and the base module using the text display cable (2.5m). The text display cable can be extended up to 10m using an extension cable (D-sub 9-pin).

- Backlight durability is the number of hours it takes for the light to become 50% of the original brightness.
- Display durability is calculated under ordinary operating and storage conditions: room temperature, normal humidity below 65% RH, and not subjected to direct sunlight.

Expansion I/O Module

Expansion I/O Module Model Number		FL1B-M08B1S2	FL1B-M08B2R2	FL1B-M08D2R2	FL1B-M08C2R2	FL1B-J2B2	FL1D-K2BM2	
Power Supply	Rated Power Voltage	24V DC	12/24V DC	24V AC/DC	100 to 240V AC/DC	12/24V DC	24V DC	
	Allowable Voltage Range	20.4 to 28.8V DC	10.8 to 28.8V DC	20.4 to 26.4V AC 20.4 to 28.8V DC	85 to 265V AC 100 to 253V DC	10.8 to 28.8V DC	20.4 to 28.8V DC	
	Rated Frequency	—	—	50/60Hz (47 to 63Hz)	50/60Hz (47 to 63Hz)	—	—	
	Current Draw	30 to 45mA	30 to 140mA (12V DC) 20 to 75mA (24V DC)	40 to 110mA (24V AC) 20 to 75mA (24V DC)	10 to 30mA (100V AC) 10 to 20mA (240V AC) 5 to 15mA (100V DC) 5 to 10mA (240V DC)	25 to 50mA	25 to 50mA	
	Allowable Momentary Power Interruption	—	2ms (Typ.) (12V DC) 5ms (Typ.) (24V DC)	5ms (Typ.) (24V AC/DC)	10ms (Typ.) (100V AC/DC) 20ms (Typ.) (240V AC/DC)	2ms (Typ.) (12V AC/DC) 5ms (Typ.) (24V AC/DC)	5ms (Typ.)	
	Power Consumption	0.8 to 1.1W	0.3 to 1.7W (12V DC) 0.4 to 1.8W (24V DC)	0.9 to 2.7VA (24V AC) 0.4 to 1.8W (24V DC)	1.1 to 3.5VA (100V AC) 2.4 to 4.8VA (240V AC) 0.5 to 1.8W (100V DC) 1.2 to 2.4W (240V DC)	0.3 to 0.6W (12V DC) 0.6 to 1.2W (24V DC)	0.6 to 1.2W (24V DC)	
	Reverse Polarity Protection	Yes	Yes	—	—	Yes	Yes	
Input	Input Signal	DC input	DC input	AC/DC input	AC/DC input	Analog input	—	
	Input Points	4	4	4	4	—	—	
	Isolation	—	—	—	—	—	—	
	Allowable Voltage Range	0 to 28.8V DC	0 to 28.8V DC	0 to 26.4V AC 0 to 28.8V DC	0 to 265V AC 0 to 253V DC	—	—	
	Operating Range	OFF Voltage	< 5V DC	< 5V DC	< 5V AC/DC	< 40V AC < 30V DC	—	—
		ON Voltage	≥ 12V DC	≥ 8.5V DC	≥ 12V AC/DC	≥ 79V AC ≥ 79V DC	—	—
		OFF Current	< 0.85mA	< 0.85mA	< 1.0mA	< 0.03mA	—	—
		ON Current	≥ 2mA	≥ 1.5mA	≥ 2.5mA	≥ 0.08mA	—	—
	Turn ON Time	1.5ms (Typ.)	1.5ms (Typ.)	1.5ms (Typ.)	100V AC: 50ms (Typ.) 240V AC: 30ms (Typ.) 100V DC: 25ms (Typ.) 240V DC: 15ms (Typ.)	—	—	
	Turn OFF Time	1.5ms (Typ.)	1.5ms (Typ.)	1.5ms (Typ.)	100V AC: 65ms (Typ.) 240V AC: 105ms (Typ.) 100V DC: 95ms (Typ.) 240V DC: 125ms (Typ.)	—	—	
	Analog Input Points	—	—	—	—	2	—	
	Analog Input Range	—	—	—	—	0 to 10V (max. rated input: 28.8V) 0 to 20mA (max. rated input: 40mA)	—	
Digital Resolution	—	—	—	—	10 bits (0 to 1000)	—		
Input Error	—	—	—	—	±1.5% (of full scale)	—		
Input Impedance	—	—	—	—	76kΩ (0 to 10V) 155 to 250Ω (0 to 20mA)	—		
Sampling Cycle	—	—	—	—	50ms	—		

Expansion I/O Module Specifications con't on next page.

OT Touchscreens

PLCs

Automation Software

Power Supplies

Sensors

Communication

Barriers

Expansion I/O Module, con't

Expansion I/O Module Model Number		FL1B-M08B1S2	FL1B-M08B2R2	FL1B-M08D2R2	FL1B-M08C2R2	FL1B-J2B2	FL1D-K2BM2
Output	Wire Length	100 m	100 m	100 m	100 m	10 m (twisted-pair shielded cable)	—
	Output	Transistor source	Relay	Relay	Relay	—	Analog
	Output Points/ Contact Configuration	4 points (separate)	4NO contacts	4NO contacts	4NO contacts	—	—
	Isolation	—	Isolated	Isolated	Isolated	—	—
	Dielectric Strength (between power/input terminals and output terminals)	—	2500V AC, 1 minute 500V DC, 1 minute	2500V AC, 1 minute 500V DC, 1 minute	2500V AC, 1 minute 500V DC, 1 minute	—	—
	Output Voltage	External power voltage (20.4 to 28.8V DC)	—	—	—	—	—
	Maximum Load Current	0.3A	Resistive load 5A at 12/24V AC/DC 5A at 100/120V AC 5A at 230/240V AC Inductive load 2A at 12/24V AC/DC 3A at 100/120V AC 3A at 230/240V AC	Resistive load 5A at 12/24V AC/DC 5A at 100/120V AC 5A at 230/240V AC Inductive load 2A at 12/24V AC/DC 3A at 100/120V AC 3A at 230/240V AC	Resistive load 5A at 12/24V AC/DC 5A at 100/120V AC 5A at 230/240V AC Inductive load 2A at 12/24V AC/DC 3A at 100/120V AC 3A at 230/240V AC	—	—
	Short-circuit Protection	Built-in current limiting resistor: Approx. 1A	External fuse required: 16A maximum	External fuse required: 16A maximum	External fuse required: 16A maximum	—	Yes
	Minimum Switching Load	—	10mA, 12V DC	10mA, 12V DC	10mA, 12V DC	—	—
	Initial Contact Resistance	—	100 mΩ maximum (at 1A, 24V DC)	100 mΩ maximum (at 1A, 24V DC)	100 mΩ maximum (at 1A, 24V DC)	—	—
	Mechanical Life	—	10 million operations (no load, 10Hz)	10 million operations (no load, 10Hz)	10 million operations (no load, 10Hz)	—	—
	Electrical Life	—	100,000 operations (rated resistive load) 1800 operations/hour	100,000 operations (rated resistive load) 1800 operations/hour	100,000 operations (rated resistive load) 1800 operations/hour	—	—
	Analog Output Points	—	—	—	—	—	2
	Analog Output Range	—	—	—	—	—	0 to 10V, 4-20mA
	Digital Resolution	—	—	—	—	—	10 bits (0 to 1000V)
	Output Error	—	—	—	—	—	±2.5% (of full scale)
Output Impedance	—	—	—	—	—	5kΩ	
Analog Value Conversion Interval	—	—	—	—	—	50ms	
Wire Length	—	—	—	—	—	10 m (twisted-pair shielded cable)	
Switching Rate	Mechanical Load	—	10Hz	10Hz	10Hz	—	—
	Electrical Load	10Hz	—	—	—	—	—
	Resistive Load/Lamp Load	10Hz	2Hz	2Hz	2Hz	—	—
	Inductive Load	0.5Hz	0.5Hz	0.5Hz	0.5Hz	—	—

General

Item		Specification	Standard
Operating Temperature	Horizontal Mounting	0 to 55°C	Cold: IEC60068-2-1 Hot: IEC60068-2-2
	Vertical Mounting	0 to 55°C	
Storage/Transportation Temperature		-40 to +70°C ¹	—
Relative Humidity		10 to 95% RH ²	IEC60068-2-30
Atmospheric Pressure		795 to 1080 hPa	—
Operating Condition		No corrosive gas	—
Degree of Protection		IP20	—
Vibration Resistance		5 to 9Hz, amplitude 3.5mm 9 to 150Hz, acceleration 9.8m/s ² (1G)	IEC60068-2-6
Shock Resistance		147m/s ² (15G)	IEC60068-2-27
Drop Test		50mm	IEC60068-2-31
Drop Test (packaged)		1m	IEC60068-2-32
Emission		Class B Group 1 ³	EN55011
Electrostatic Discharge		8kV air discharge 6kV contact discharge ⁴	IEC61000-4-2
Electromagnetic Fields		10V/m	IEC61000-4-3
Burst Pulses		2kV (power line) 1kV (I/O signal line) ⁵	IEC61000-4-4
Energy Carriers Single Pulse (Surge) ⁶ (FL1B-H12RCC, FL1B-B12RCC only)		1kV (power line) normal 2kV (power line) common	IEC61000-4-5
Communication Cable		0.5 to 2.5mm ² (one wire) 0.5 to 1.5mm ² (two wires)	—
Terminal Style		Finger-safe type ⁷	—

-  1. No freezing
- 2. No condensation
- 3. Class A for AS-Interface communication module
- 4. 8kV (air discharge), 4kV (contact discharge) for AS-Interface communication module
- 5. 1kV (criteria A), 2kV (criteria B) for AS-Interface communication module
- 6. For protection against surge noise on DC power supply types (FL1D-H12RCE/B12RCE, FL1D-H12SND, FL1D-H12RCA/B12RCA), use surge absorbers, noise cut transformers, or noise filters.
- 7. Tightening torque 0.4 to 0.5 N·m

AS-Interface Communication Module

Specifications

Module Type	AS-Interface slave module
Slave Type	Standard
Profile	I/O code: 7
	ID code: F
	ID2 code: F
Input/Output	Virtual input: 4
	Virtual output: 4
AS-Interface Voltage	30V DC (26.5 to 31.6V DC)
Current Draw	70 mA maximum (AS-Interface)

I/O Allocation

Input		Output	
AS-Interface	SmartRelay	SmartRelay	AS-Interface
Output Data Bit D0	Input In	Output Qm	Input Data Bit D0
Output Data Bit D1	Input In+1	Output Qm+1	Input Data Bit D1
Output Data Bit D2	Input In+2	Output Qm+2	Input Data Bit D2
Output Data Bit D3	Input In+3	Output Qm+3	Input Data Bit D3

-  1. I/O point numbers “n” and “m” of the SmartRelay are automatically allocated by the base module according to the mounted position of the AS-Interface communication module.
- 2. AS-Interface communication module is IP20 terminal type.
- 3. AS-Interface cable is connected to the terminal block.

I/O Touchscreens

PLCs

Automation Software

Power Supplies

Sensors

Communication

Barriers

01 Touchscreens

PLCs

Automation Software

Power Supplies

Sensors

Communication

Barriers

Dimensions (mm)

Base Module

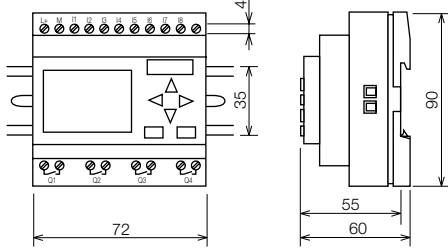

Expansion I/O Module, Communication Module

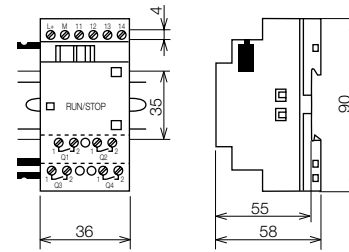

Mounting Hole Layout (Using Mounting Slides)

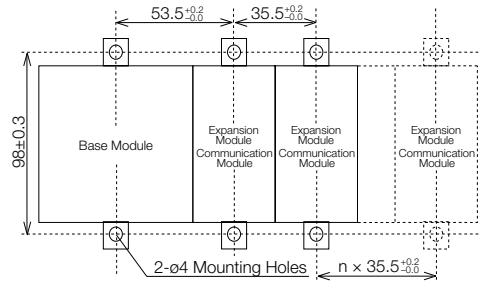

Text Display

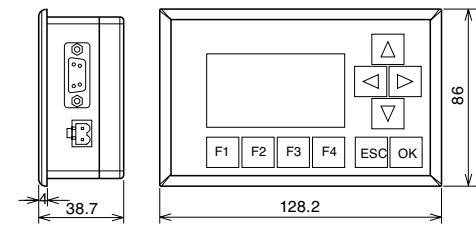

Installation

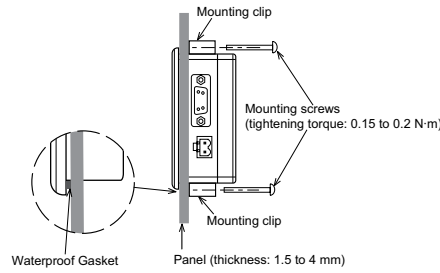

Mounting Hole Layout

