

HE5B Series Pushbutton Enabling Switch

HE5B Key features include:

- Ergonomically-designed OFF-ON-OFF 3-position operation
- Easy recognition of position 1 → 2 transition, made possible by snap action switch
- Sufficient load difference is provided for shifting from position 2 → 3
- Light force needed to maintain position 2, so that operators can easily use the enabling switch
- The switch does not turn ON when being released from position 3 (OFF when pressed) to position 1 (OFF when released) (IEC60204-1, 9.2.5.8)
- Two contacts are provided for safety
- IP65 (using the waterproof rubber cover)
- Mounts in a 16mm (5/8") round hole



Specifications

Conforming to Standards	IEC60947-5-1, EN60947-5-1 (DEMKO approval), JIS C8201-5-1, UL508 (UL recognized), CSA C22.2, No. 14 (c-UL recognized)
Application Standards	ISO 12100/EN292, IEC60204-1/EN60204-1 ISO11161/prEN11161, ISO10218/EN775 ANSI/RIA R15.06, ANSI B11.19
Operating Temperature	Silicone rubber boot: -25 to 60°C (no freezing) NBR/PVC Polyblend rubber boot: -10 to 60°C (no freezing)
Relative Humidity	45 to 85% RH (no condensation)
Storage Temperature	-40 to +80°C (no freezing)
Operating Environment	Degree of pollution: 2 (panel inside/terminal side) Degree of pollution: 3 (panel outside/operator side)
Contact Resistance	50 mΩ maximum (initial value)
Insulation Resistance (DC megger)	Between live and dead metal parts: 100 MΩ minimum Between terminals of different pole: 100 MΩ minimum
Impulse Withstand Voltage	1.5 kV
Operating Frequency	1200 operations per hour
Mechanical Life	Position 1 → 2 → 1: 1,000,000 operations minimum Position 1 → 2 → 3 → 1: 100,000 operations minimum
Electrical Life	100,000 operations minimum
Shock Resistance	Operating extremes: 100 m/s ² (10 G) Damage limits: 500 m/s ² (50 G)
Vibration Resistance	Operating extremes: 5 to 55 Hz, amplitude 0.5 mm minimum Damage limits: 5 to 55 Hz, amplitude 0.5 mm minimum
Terminal Style	Solder Terminal
Recommended Wire	0.5 mm ² maximum per line (20AWG)
Solder Heat Resistance	260°C, 3 seconds maximum
Terminal Pulling Strength	20 N minimum
Recommended Tightening Torque of Locking Ring	0.29 to 0.49 N·m
Degree of Protection	IP65
Conditional Short-circuit Current	50A (250V) (Use 250V/10A fast acting type fuse for short circuit protection.)
Operator Strength	250N minimum (when pressing the entire surface of the operator)
Weight (approx.)	9 g

Part Numbers

Model		Contact Arrangement	Color	Part Number
With Rubber Cover	Silicone Rubber	DPDT	Yellow	HE5B-M2PY
			Black	HE5B-M2PB
	NBR/PVC		Gray	HE5B-M2PN1

 NBR/PVC cover comes in gray only.

Current Ratings

Rated Insulation Voltage (Ui)		125V	
Thermal Current (Ith)		3A	
Rated Operating Voltage (Ue)		30V	125V
Rated Operating Current (Ie)	AC	Resistive Load (AC-12)	0.5A
		Inductive Load (AC-15)	0.3A
	DC	Resistive Load (DC-12)	1A
		Inductive Load (DC-13)	0.7A
Contact Configuration (3 Position Switch)		2 contacts (DPDT)	

 Minimum applicable load (reference): 3V AC/DC, 5mA.

Circuit Diagrams

Terminal Arrangement (Bottom View)

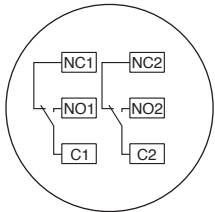

-  1. 3 position switch: 2 contacts, terminal no. = between NO1-C1, between NO2-C2
2. Use between NO-C for OFF → On → OFF 3 position switch (NC is not used).

Mounting Hole Layout

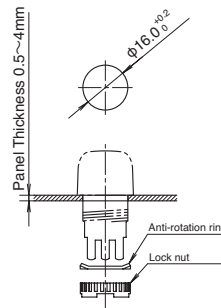

-  1. Recommended tightening torque for Locking Ring: 0.29 to 0.49 N·mm.
2. Use a lock nut tool to screw on the lock nut (see page 415).

Operating Characteristics

Operating Characteristics (without rubber cover/center of button being pushed)

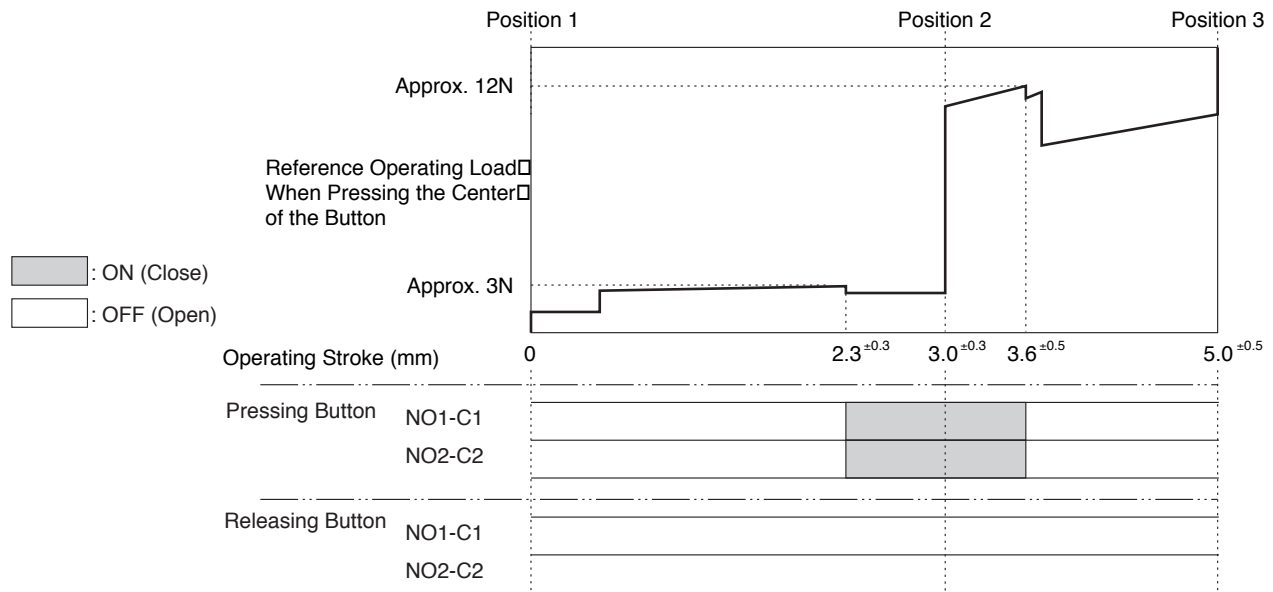

Operating load depends on ambient temperature.

Dimensions (mm) With Rubber Cover

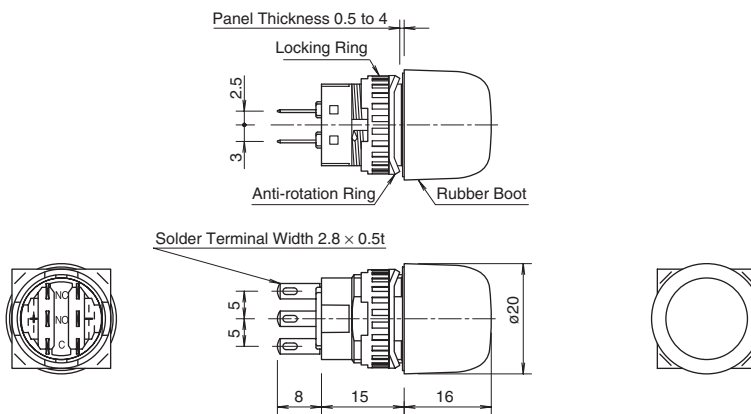

Accessories Replacement Rubber Cover

Appearance	Part Number	Material	
	Silicon Rubber	Yellow	HE9Z-D5Y
		Black	HE9Z-D5B
	NBR/PVC Polyblend	Gray	HE9Z-D5N1

NBR/PVC cover comes in gray only.

Lock Nut Tool

Appearance	Part Number	Material
	MT-001	Metal

General Information

Safety Precautions

- In order to avoid electric shock or fire, turn power off before installation, removal, wire connection, maintenance or inspection of switch.
- Follow specification when installing. Improper electrical load may damage switch, cause electric shock, or fire.

- Use proper wire diameter to meet voltage and current requirements. Using improper wires or incomplete soldering may cause fire due to abnormal heat generation.

Installation Precautions

HE2B

- M3 nut is inside the rubber cover.

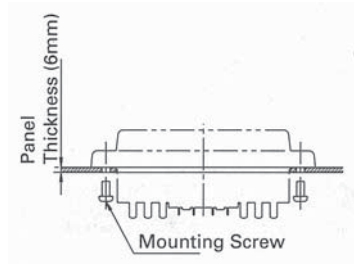

HE2B/HE3B

- A change in internal air pressure may cause the rubber boot to expand and shrink on an enabling switch that has the rubber boot sealed. This may affect the performance of the switch. Periodically check to ensure that the enabling switch is operating correctly.

- If the panel is not level when mounting an enabling switch, the waterproof feature cannot be guaranteed.

HE3B

- The rubber boot has a tab to be used for orientation. When making a positioning hole in a panel, do not make a hole in the rubber boot, or the waterproof feature cannot be guaranteed. When the positioning hole is not on the panel, remove the tab, but do not make a hole in the rubber boot.
- When tightening the locking ring, secure the flange to prevent the enabling switch from rotating. In applications where the enabling switch is to be rotated, mount the switch in a recess on the panel as shown.

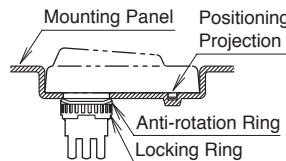

Wiring Precautions

HE1B/HE2B/HE3B

- Applicable wire size is 0.5mm² (20AWG) (maximum) / 1 line.
- When soldering the terminal, solder at a temperature of 260°C within 3 seconds. Use non-corrosive liquid rosin as soldering flux.

- Recommended Torque

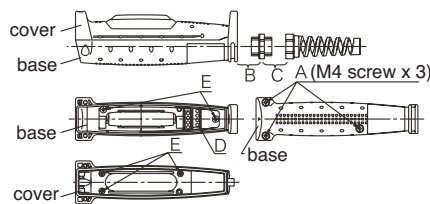

HE1G

- Wire Stripping Information

Wire Length	Terminal Number 1-4	Terminal Number 5-8
L1, L2 (mm)	L1=40mm	L2=27mm
L3 (mm)	L3=6mm	

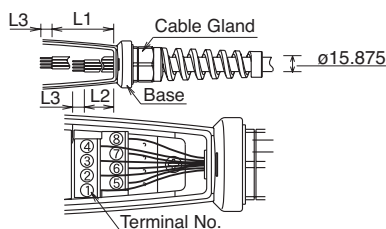

- Applicable Wire Size: 0.14 to 1.5mm² (24 - 16AWG, one wire per terminal)

	See Drawing Above	Recommended Torque
Rubber Boot & Base	A	1.2±0.1Nm
Connector & Grip Switch	B	4.0±0.3Nm
Connector	C	4.0±0.3Nm
Terminal Screw	D	0.5±0.6Nm
Do Not Remove	E	

Use Precautions

HE2B/HE3B/HE1G

- To ensure the highest level of reliability connect both contacts to a monitoring device such as a safety relay.

HE1B/HE2B/HE3B

- When installing the enabling switch ensure that it cannot be accidentally activated. For example, a protrusion from a teaching pendant could cause the enabling switch to be activated by the weight of the teaching pendant.